



# **Breeze User Guide**

## **Breeze**

### **Multiple Stream Video Processors**

Light and Standard Editions

Version 5.3.2

Copyright © 1989 - 2007 Discovery Scientific, LLC

All rights reserved

[www.DiscoveryBiz.net](http://www.DiscoveryBiz.net)

*January 01, 2007*

## **Breeze, Multiple Stream Video Processors**

Light and Standard Editions

Copyright © Discovery Scientific, LLC

Version 5.3.2 – January, 2007

Discovery Scientific, LLC

P.O. Box 65510  
Lubbock, TX 79464-5510  
USA

[support@DiscoveryBiz.net](mailto:support@DiscoveryBiz.net)

[www.DiscoveryBiz.net](http://www.DiscoveryBiz.net)

This guide, as well as the software described in it, are furnished under the license and may be used or copied only in accordance with the terms of such license. The content of this guide is furnished for informational use only, and should not be considered as a commitment by Discovery Scientific, LLC. Discovery Scientific, LLC assumes no responsibility or liability for any errors or inaccuracies that may appear in this document.

Except as permitted by such license, no part of this document may be reproduced or transmitted in any form or by any means, electronic or mechanical, for any purpose, without the express written permission of Discovery Scientific, LLC.

Information in this document is subject to change without notice.

Printed in the United States of America

All products and corporate names may be trademarks or registered trademarks of their respective companies.

---

|   |    |
|---|----|
| 1. About Breeze .....                         | 1  |
| 2. Overview of Breeze .....                   | 2  |
| Breeze editions .....                         | 2  |
| Breeze main window .....                      | 3  |
| Browser window .....                          | 4  |
| Channels, video ports, video panels .....     | 6  |
| Operational Modes .....                       | 8  |
| Supported video and image formats .....       | 9  |
| System requirements .....                     | 10 |
| Breeze Support .....                          | 11 |
| 3. Breeze menus .....                         | 12 |
| File menu commands .....                      | 12 |
| Edit menu commands .....                      | 15 |
| View menu commands .....                      | 16 |
| Image menu commands .....                     | 21 |
| Channel menu commands .....                   | 22 |
| Go menu commands .....                        | 24 |
| Tools menu commands .....                     | 27 |
| Window menu commands .....                    | 28 |
| Help menu commands .....                      | 29 |
| Pop up menu of a browser window .....         | 30 |
| 4. Toolbars .....                             | 31 |
| "Standard" toolbar .....                      | 31 |
| "Go" toolbar .....                            | 32 |
| "Channel" toolbar .....                       | 33 |
| "View" toolbar .....                          | 34 |
| "Zoom" toolbar .....                          | 35 |
| Status Bar .....                              | 36 |
| 5. "Options" dialogs .....                    | 37 |
| "General" options dialog box .....            | 38 |
| "Channels" options dialog box .....           | 38 |
| "Read stream" options dialog box .....        | 39 |
| "Save sequence" options dialog box .....      | 41 |
| "Capture image" options dialog box .....      | 44 |
| "Video" options dialog box .....              | 47 |
| "Set 'Save' paths" options dialog box .....   | 49 |
| "File formats: YUV" options dialog box .....  | 51 |
| "File formats: JPEG" options dialog box ..... | 55 |
| "File formats: PNG" options dialog box .....  | 57 |
| "Reference frames" options dialog box .....   | 60 |
| 6. "File manager" dialog boxes .....          | 61 |
| File "Open" / "Open To" dialog box .....      | 62 |
| File Save / Save As dialog box .....          | 64 |

---

- Select folder dialog box ..... 66
- "Close From" dialog box ..... 67
- Controller panel of a browser window ..... 68
- 7. Install/Uninstall/Repair/Activate ..... 71
  - Install the Breeze ..... 71
  - Uninstall the Breeze ..... 77
  - Repair the Breeze ..... 80
  - Activate the Breeze ..... 82
- 8. Breeze license ..... 83

## 1. About Breeze

Breeze, Multiple Stream Video Processor, is a software tool operating with multiple streams of video sequences or / and individual images. It may play, record, convert, replay back and forth video sequences, view and edit images within local computer, via local intra net and Internet.

User interface of Breeze allows operating with video streams and individual images similarly, in a simple intuitive and uniform fashion. You can step back and forth through the hundreds and thousands of images, play them back and forth, compare them side by side, capture and save images of your choice "on the fly" or save all of them. Think about Breeze as about several "video books of pictures" you can thumb and scroll back and forth at once.

For business users Breeze is a unique and effective tool for a side by side, comparative analysis of video and images, in the number of areas such as professional sport, security, scientific, medical, video and photo editing applications and many more.

Breeze supports 70+ video and image formats including MPEG-1, MPEG-2, VOB, H.264, OOV, BMP, JPEG, PNG, TIFF, 50+ YUV/YCbCr formats.

To receive latest news about Breeze, to download most recent upgrades of Breeze packages, to read extended Breeze help and FAQ (Frequently Asked Questions), to download additional support documentation, visit Breeze support web site [www.DiscoveryBiz.Net](http://www.DiscoveryBiz.Net).

You may contact Breeze support via e-mail: [support@DiscoveryBiz.net](mailto:support@DiscoveryBiz.net).

Breeze support web site: [www.DiscoveryBiz.Net](http://www.DiscoveryBiz.Net).

## 2. Overview of Breeze

### ***Breeze editions***

There are three main editions of Breeze:

|                                    |  |
|------------------------------------|--|
| <b>Breeze Light Edition</b>        | basic set of features processes 1 streaming channel.   |
| <b>Breeze Standard Edition</b>     | full set of features processes up to 2 streaming channels.   |
| <b>Breeze Professional Edition</b> | professional set of features processes up to 4 streaming channels custom versions processes up to 1024 channels. |

|   | <b>Breeze Light</b> | <b>Breeze Standard</b> | <b>Breeze Professional</b> |
|---|---------------------|------------------------|----------------------------|
| View images   | √                   | √                      | √                          |
| Slide show  | √                   | √                      | √                          |
| Play image or video sequence forward or / and backward.   | √                   | √                      | √                          |
| Record image or / and video sequence.   | √                   | √                      | √                          |
| Individual capturing images from video sequences.   | √                   | √                      | √                          |
| Exchange of images between any of Breeze video ports and clipboard, back and forth.   | √                   | √                      | √                          |
| Zoom image operations   | √                   | √                      | √                          |
| Opening input image of video file or / and stream via file manager with preview image window  | √                   | √                      | √                          |
| Saving images from any video port of Breeze to the graphical file via file manager with preview image window  | √                   | √                      | √                          |
| Number of processed steaming channels   | 1                   | 2                      | 4                          |
| Custom number of channels   | √                   | √                      | up to 1024                 |
| Synchronous playing, recording and processing of image or video sequences in the primary and assistant channels back and forth in the same or opposite directions | √                   | √                      | √                          |
| Regulated "on the fly" speed of playing, recording, processing  | √                   | √                      | √                          |
| Fast "on the fly" synchronous / asynchronous reversing of play direction  | √                   | √                      | √                          |
| Basic image processing functions  | √                   | √                      | √                          |
| Full set of image processing functions  | √                   | √                      | √                          |
| Advanced professional set of image processing functions   | √                   | √                      | √                          |
| Custom set of user interface, application and image processing features   | √                   | √                      | √                          |

## Breeze main window

Breeze main window includes the following user interface components:

- Title bar
- Main menu
- Toolbars
- Status bar

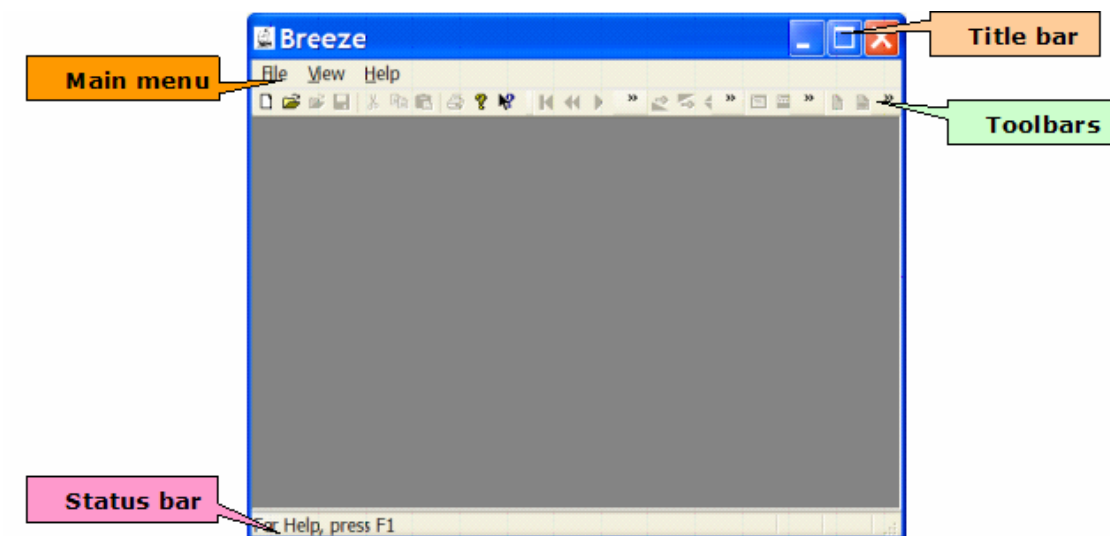

Title bar displays names of open input documents (files, video streams, images etc.).

Main menu provides an access to the majority of commands available in Breeze. Most frequently used commands are also available in the pop-up menu invoked by the clicking the right button of a mouse.

Toolbars is another handy way to access Breeze commands. All commands supported by toolbars are also available in the main menu.

Status bar is used to display text information about current state of a browser window, menus, toolbars etc.

At the image you may see above in this help topic main window is shown in its simplest state when there are no browser window opened. In this state main window can implement just a few simple functions. To gain an access to more functions a browser window has to be opened.

Use command New from the file menu to create a new browser window with empty document (no files, video streams or images opened).

You can open an existing document (file, stream etc.) to the new browser window with the Open command from the file menu.

## Browser window

Breeze browser window includes several main user interface components:

- Primary video panel
- Assistant video panel
- Controller panel
- Title bar
- Main menu
- Toolbars
- Status bar
- Scroll bars

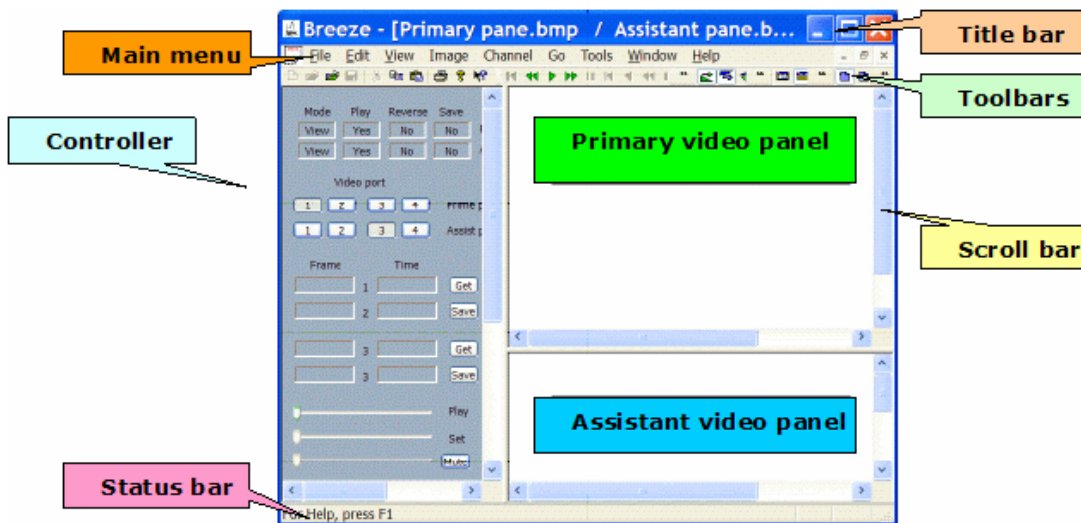

Primary and assistant video panels display video data. By default primary channel is connected via the video output port 1 to the primary video panel, and assistant channel is connected via the video output port 3 to the assistant video panel. But if it is necessary each video panel can be connected to any of 4 available video ports.

Title bar displays names of open input documents, files, video streams, images etc. for primary and assistant channels.

Main menu provides an access to the majority of commands available in Breeze. Most frequently used commands are also available in the pop-up menus invoked by the clicking the right button of a mouse.

Toolbars is another handy way to access Breeze commands. All commands supported by toolbars are also available in the main menu.

Status bar is used to display text information about current state of a browser window, menus, toolbars etc.

Each of 3 main panels of a browser window has its own scroll bars, horizontal and vertical ones. They allow reaching any part of a panel when size of Breeze frame window is small.



Browser window can be configured according to the concrete job. All components of browser window can be hidden or shown at any time, except primary video panel. Controller and assistant video panels, toolbars and status bar can be hidden or shown in all available display modes. Title bar, main menu, toolbars and status line are hidden or shown automatically during a switching between the normal and full screen display modes.

When work in Breeze is completed and it is closing, configuration of a browser window is saved. When Breeze starts next time a browser window restore its configuration from the saved data.

## Channels, video ports, video panels

Breeze is able to process several input data streams. Those data streams are called channels.

Depending on edition, Breeze can process different number of channels. See topic Breeze editions for details.

User can select and control one or two input channels, called "Primary" channel and "Assistant" channel.

Video data processed by Breeze are sent to the video output ports. Video output port, or in short "video port", is a temporary intermediate storage holding one image at any given moment of the time. Image from the video port can be displayed in video panels or used for other purposes depending on the user's choice.

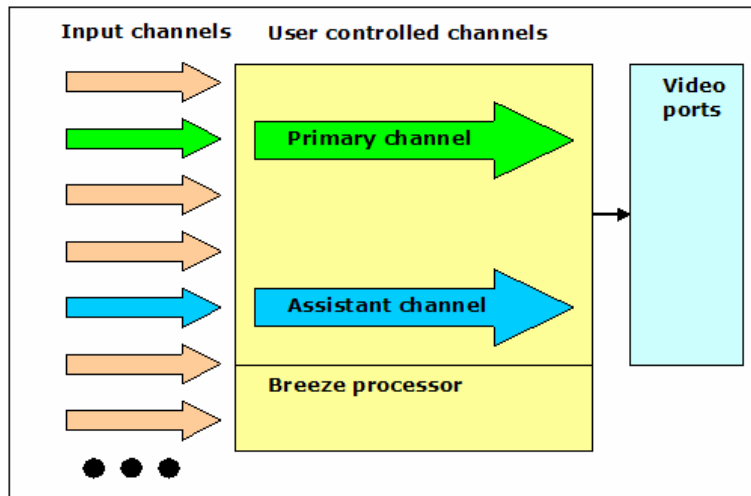

In the Breeze there are 4 video output ports available. Ports are numbered from 1 to 4. Two video ports, number 1 and 2, are serving the primary channel. Another two ports, number 3 and 4, are serving the assistant channel. Video port 1 is used for the majority of video output data produced by the primary channel, and video port 2 is used for a more rarely used video output data. Correspondingly, video port 3 is used for the majority of video output data produced by the assistant channel, and video port 4 is used for a more rarely used video output data.

Video output ports 1 and 3 are major video output ports. Video output ports 2 and 4 are auxiliary video output ports.

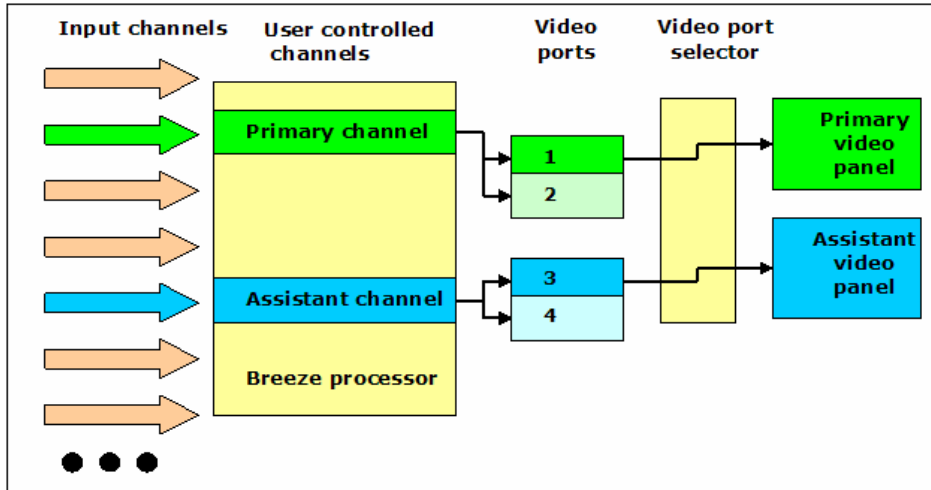

By default primary channel is connected via the video output port 1 to the primary video panel, and assistant channel is connected via the video output port 3 to the assistant video panel. But if it is necessary each video panel can be connected to any of 4 available video ports.

Availability of 2 video output ports for each streaming channel and 2 video panels able to display data from any of 4 video ports, allows reconfiguring browser window for a variety of jobs.

## Operational Modes

There are several main types of jobs implemented with video data in each streaming channel. Those main types of jobs are called "Operational modes" of a streaming channel. Table 1 enlists main operational modes currently supported by Breeze.

| Operational mode         | Streaming channel | Data source       | Description  |
|--------------------------|-------------------|-------------------|--|
| <b>CLOSED</b>            | Closed            | Unavailable       | Video output is unavailable. Main controls in the browser window are disabled.   |
| <b>VIEW / SLIDE SHOW</b> | Open              | Original stream   | User loads one image in a time per channel by applying "Step" / "Step back" commands.  |
| <b>PLAY</b>              | Open              | Original stream   | Single video stream or sequence of individual images is played automatically with a predefined frame rate. User starts and stops playing by applying "Start" / "Stop" / "Pause" commands.  |
| <b>REPLAY</b>            | Open              | Video cash buffer | Frames stored in the video cash buffer during "PLAY" mode are replayed back and forth automatically with a predefined frame rate; or are stepped back and forth. User controls playing and stepping by applying "Replay forth" / "Replay back" / "Replay step" / "Replay step back" / "Pause replay" commands. |
| <b>EDIT</b>              | Open              | Original stream   | User edit selected image in the separate image editor window.  |
| <b>CONVERT</b>           | Open              | Original stream   | Selected video or image sequence is converted automatically from one format into another. User starts, stops and pauses process of conversion.   |

Current operational mode for each channel is shown in the left top corner of Controller panel, in the two text boxes titled "Mode".

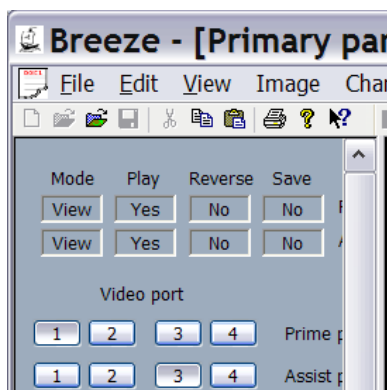

## **Supported video and image formats**

Currently Breeze supports 45 video formats and 45 image formats.

### **Video formats (all frames are in the single file or stream).**

- MPEG 1
- MPEG 2
- VOB
- 42 YUV / YCbCr video file formats

### **Image formats (each image in the separate file or stream).**

- BMP, Microsoft Bitmap
  - 1 bit monochrome
  - 4 bit color palette
  - 8 bit color palette
  - 16 bit RGB,
  - 24 bit RGB
  - 32 bit RGB with transparency
- JPEG / JFIF
  - color
  - gray, 8 bit
- PNG, Portable Network Graphics
  - gray, 1 bit, 2 bit, 4 bit, 8 bit
  - gray with alpha transparency, 8 bit
  - color palette, 1 bit, 4 bit, 8 bit
  - RGB, 8 bit
  - RGB with transparency, 8 bit
- 42 YUV / YCbCr image file formats

Video sequences presented by video formats as well as video sequences presented by individual images can be viewed, played, replaed back and forth, converted to another video or image format, saved to file or data stream.

## **System requirements**

Breeze v.5.3.2 works with Windows 2000 or Windows XP.

The minimum hardware requirements to the computer are the following:

- CPU: Pentium III or higher
- RAM: 128 Mbytes or more

Current version of Breeze has been tested on x86 platforms with up to:

- CPU: total, 4 processors or/and cores, running at the frequencies up to 3.8 GHz
- RAM: 16 gigabytes.

It is IMPORTANT to remember that CPU and RAM resources required for processing video or graphics depend on structure and complexity of processed video data. Usually most important are size of picture frame, level of video compression, frame rate of video sequences and number of simultaneously processed video streams.

For example, size of QCIF picture is  $176 \times 144 = 25344$  pixels. Size of HDTV 1080p video picture is  $1920 \times 1080 = 2073600$  pixels, or about 80 time bigger than size of QCIF picture. Often it means that processing HDTV 1080p picture will require about 80 times more computations than processing of QCIF picture.

Breeze has been tested for processing of pictures with the size up to  $6000 \times 3000$  pixels, or about 10 times bigger than HDTV 1080p (about 1000 times bigger than QCIF).

Usually encoding and /or decoding of highly compressed video or graphics requires a big CPU power. Fast reversible replaying of video sequences (instant playback) is done usually via storing a big number of frames in RAM. It may require a big quantity of RAM, up to 2 gigabytes and more.

Breeze essentially is a multiple stream processor. On the computers equipped with multiple processors (with single or multiple cores), Breeze may process data in multiple threads, utilizing all CPU resources.

As a result, in the case of most demanding tasks, if it is required by the complexity of job, Breeze may utilize all CPU and RAM resources available at the computer.

## **Breeze Support**

Address: Discovery Scientific, LLC  
P.O. Box 65510  
Lubbock, TX 79464-5510  
USA

E-mail: [support@DiscoveryBiz.net](mailto:support@DiscoveryBiz.net)

Web: [www.DiscoveryBiz.net](http://www.DiscoveryBiz.net)

Click here to see "[What is new in the Breeze](#)" - learn more about new releases of Breeze.

Click here to see "[Frequently Asked Questions](#)" - learn more about Breeze features.

### 3. Breeze menus

#### **File menu commands**

##### **New command**

Use this command to create a new document in the Breeze browser window.

You can open an existing document (file, stream etc.) with Open or Open To command.

##### **Open command**

Use this command to open an existing document in a new window.

Select the file you want to open in the File Open dialog

In the new window a document (file, stream etc.) is opened to the primary channel.

You can create new documents with the New command.

You can open an existing document (file, stream etc.) to the channel of already created browser window with the Open To command.

##### **Open To command**

Use this command to open an existing document to the channel of already created browser window.

Select the file you want to open in the File "Open To" dialog box.

In the new window a document (file, stream etc.) is opened to the primary channel.

You can create new documents with the New command.

You can open an existing document (file, stream etc.) in the window with the Open command.

##### **Close command**

Use this command to close all windows containing the active document.

Breeze suggests that you save changes to your document before you close it. If you close a document without saving, you lose all changes made since the last time you saved it. Before closing an untitled document, Breeze displays the Save As dialog box and suggests that you name and save the document.

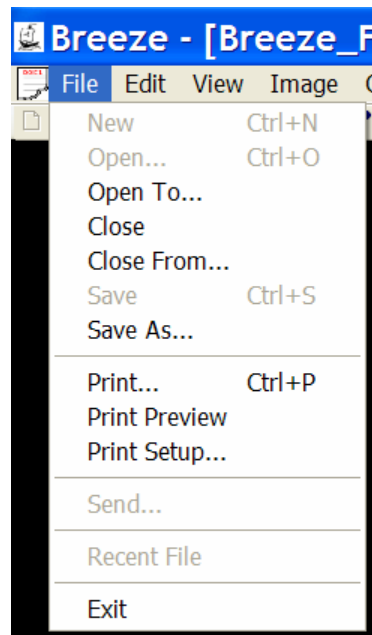

the

box.



### "Close From" command

Use this command to close data stream from the channel of the open browser window.

Close From command does not close browser window itself.

If only one channel, primary or assistant, is open then Breeze closes that open channel.

If both channels, primary and assistant, are open, then Breeze displays dialog where you can select which channel has to be closed. Make a selection and click button "OK" if you want to close selected channels, or click button "Cancel" if you want to cancel Close From operation.

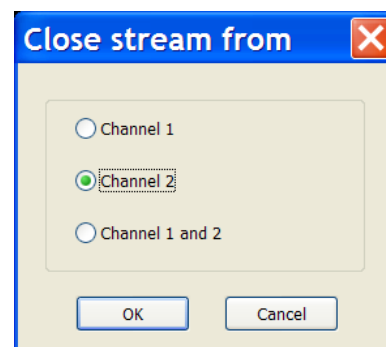

### Save command

Use this command to save the active document to its current name and directory.

When you save a document for the first time, Breeze displays the Save As dialog box so you can name your document.

If you want to change the name and directory of an existing document before you save it, choose the Save As command.

### Save As command

Use this command to save and name the active document.

Breeze displays the Save As dialog box so you can name your document.

To save a document with its existing name and directory, use the Save command.

### Print command

Use this command to print a document.

This command presents a Print dialog box, where you may specify the range of pages to be printed, the number of copies, the destination printer, and other printer setup options.

### Print Preview command

Use this command to display the active document as it would appear when printed.

When you choose this command, the main window will be replaced with a print preview window in which one or two pages will be displayed in their printed format.

The print preview toolbar offers you options to view either one or two pages at a time; move back and forth through the document; zoom in and out of pages; and initiate a print job.

### **Print Setup command**

Use this command to select a printer and a printer connection.

This command presents a Print Setup dialog box, where you specify the printer and its connection.

### **Send command**

Use this command to send the active document through e-mail.

This command presents a mail window with the active document attached to it. You may then fill out the To field, Subject field, and so on, and add text to the body of the message. When you are finished, you can click the Send button to send the message.

### **Exit command**

Use this command to end your Breeze session.

You can also use the Close command on the application Control menu. Breeze prompts you to save documents with unsaved changes.

## Edit menu commands

### Undo/Can't Undo command

Use this command to reverse the last editing action, if possible.

The name of the command changes, depending on what the last action was. The **Undo** command changes to **Can't Undo** on the menu if you cannot reverse your last action.

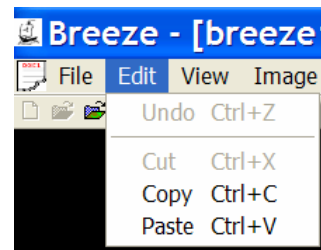

### Cut command

Use this command to remove the currently selected data from the document and put it on the clipboard.

This command is unavailable if there is no data currently selected.

Cutting data to the clipboard replaces the contents previously stored there.

### Copy command

Use this command to copy selected data onto the clipboard.

This command is unavailable if there is no data currently selected.

Copying data to the clipboard replaces the contents previously stored there.

### Paste command

Use this command to insert a copy of the clipboard contents at the insertion point.

This command is unavailable if the clipboard is empty.

## View menu commands

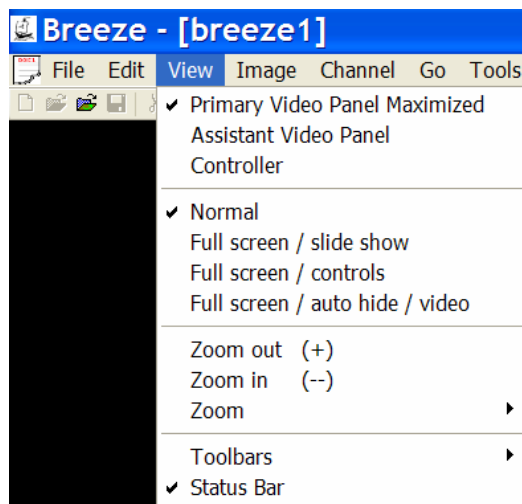

### Primary Video Panel Maximized

Use this command to maximize or minimize primary video panel.



This command hides or shows assistant and controller panels.

A checkmark appears next to the menu item when the primary video panel is maximized.

### Assistant Video Panel

Use this command to show or hide assistant video panel.



A checkmark appears next to the menu item when the assistant video panel is shown.

### Controller

Use this command to show or hide controller panel.



A checkmark appears next to the menu item when the controller video panel is shown.

These commands also available in the pop up menu of a Browser window.

First 3 buttons of the "View" toolbar corresponds to these commands too.

### "Full Screen" commands

Use this command to return a browser window from the "Full screen" state to the "Normal screen" state.

In the "Normal screen" state title bar, main menu, toolbars, and status bar are visible. If assistant video panel and controller panel were visible before browser window was switched to the "Full screen" state, then these panels becomes visible again after returning a browser to the "Normal screen" state.



A checkmark appears next to the menu item when browser window is in the "Normal screen" state.

### Full screen with controls

Use this command to switch a browser window to the "Full screen with controls" state.



This full screen state can be used for viewing individual images, for slide show, and for playing video.

In the "Full screen with controls" state a browser window uses almost all available screen area for showing images, on the one hand, and, at the same time, provides a direct access to the most important commands via the toolbars and, if it is necessary, via a controller panel, on the other hand.

In the "Full screen with controls" state title bar, main menu, and status bar are hidden.

State of assistant video panel, controller panel and toolbars is same as it was in the "Normal screen" state. It allows configuring browser window for different types of slide shows or video playing, with one or two sets of slides in the primary and / or assistant video panels.

A checkmark appears next to the menu item when browser window is in the "Full screen with controls" state.

### Full screen

Use this command to switch a browser window to the "Full screen" state.

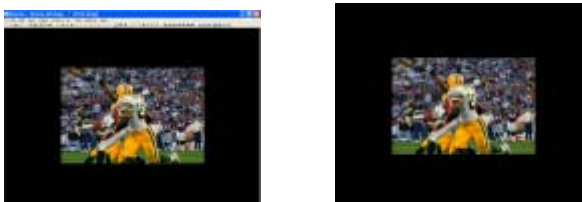

This full screen state can be used for viewing individual images, for slide show, and for playing video.

In the "Full screen" state a browser window uses all available screen area for showing images.

In the "Full screen" state title bar, main menu, toolbars and status bar are hidden.

State of assistant video panel, controller panel and toolbars is same as it was in the "Normal screen" state. It allows configuring browser window for different types of slide shows or video playing, with one or two sets of slides in the primary and / or assistant video panels.

"Full screen" state is initiated and controlled by the user via the main menu, the pop up menu of a browser window or via the "View" toolbar.

A checkmark appears next to the menu item when browser window is in the "Full screen" state.

### Full screen auto

Use this command to switch a browser window to the "Full screen auto" state.

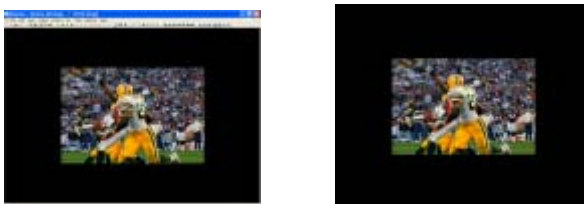

This full screen state can be used for viewing individual images, for slide show, and for playing video.

In the "Full screen auto" state a browser window uses all available screen area for showing images.

In the "Full screen auto" state title bar, main menu, toolbars and status bar are hidden.

State of assistant video panel, controller panel and toolbars is same as it was in the "Normal screen" state. It allows configuring browser window for different types of slide shows or video playing, with one or two sets of slides in the primary and / or assistant video panels.

"Full screen auto" state is initiated and controlled by the user via the main menu, the pop up menu of a browser window or via the "View" toolbar.

During playing video in the "Full screen auto" state a browser window automatically switching to the "Full screen" state if for several seconds computer keyboard and mouse are inactive. Browser window is switching automatically back to the "Normal screen" if keyboard or mouse becomes active again and send commands to the computer.

A checkmark appears next to the menu item when browser window is in the "Full screen auto" state.

"Normal", "Full screen with controls", "Full screen", "Full screen auto" commands also available in the pop up menu of a Browser window.

Last 4 buttons of the "View" toolbar corresponds to these commands too.

## **Zoom commands (View menu)**

### **"Zoom plus", "Zoom minus" commands**

Use these commands to zoom in and zoom out images in the primary and assistant video panels.

Unzoomed image corresponds to the zoom 100% or 1x.

Maximum size of a zoomed image is 1000% or 10x.

Minimum size of a zoomed image is 10% or 0.1x.

These two commands are also available in the "Zoom" toolbar as buttons (+) and (-).

### **Fixed "Zoom 1000%" to "Zoom 10%" commands**

Use these commands to zoom in and zoom out images in the primary and assistant video panels.

The full set of fixed zoom levels are the following:

1000%, 500%, 200%, 175%, 150%, 125%, 100%, 50%, 25%, 10%.

Unzoomed image corresponds to the zoom 100% or 1x.

Maximum size of a zoomed image is 1000% or 10x.

Minimum size of a zoomed image is 10% or 0.1x.

### **Fit view command**

Use this command to zoom images in the primary and assistant panels in such a way where each image fits entirely within the borders of the panel view.

Sizes of primary and assistant panels can be changed by repositioning a horizontal bar separating these two panels. In the "Fit view" zoom mode changing a size of panel leads also to the changing sizes of images displayed in the panels.

### **Fit width command**

Use this command to zoom images in the primary and assistant panels in such a way where each image fits to the width of a panel view.

### **Fit height command**

Use this command to zoom images in the primary and assistant panels in such a way where each image fits to the height of a panel view.

### **Fill view command**

Use this command to zoom images in the primary and assistant panels in such a way where each image fills an entire panel view.

### **Custom zoom command**

Use this command to set custom zoom for images in the primary and assistant panels.

A checkmark appears next to the menu item when any of above commands are selected.

"Zoom 100%", "Fit view", "Fit width", "Fit height", "Fill view" commands are also available in the "Zoom" toolbar.

## Toolbar commands (View menu)

### Toolbar "Standard" command

Use this command to display and hide the "Standard" toolbar, which includes buttons for some of the most common commands in Breeze, including:

"New", "Open", "Open To", "Save", "Cut", "Copy", "Paste", "Print", "About Breeze", "Help".

A checkmark appears next to the menu item when the "Standard" toolbar is displayed.

### Toolbar "Go" command

Use this command to display and hide the "Go" toolbar, which includes buttons for "Step" and "Play" commands, including:

"Step", "Step back", "Start", "Stop", "Pause play", "Replay step", "Replay step back", "Replay", "Replay back", "Replay stop", "Set start", "Set end".

A checkmark appears next to the menu item when the "Standard" toolbar is displayed.

### Toolbar "Channel" command

Use this command to display and hide the "Channel" toolbar, which includes buttons for the channel related commands, including:

"Enable channel 1", "Enable channel 2", "Switch enable channels", "Reverse replay direction for channel 1", "Reverse replay direction for channel 2", "Reverse both channels", "Synchronize frame output for channels", "Enable save from channel 1", "Enable save from channel 2", "Reverse enable save".

A checkmark appears next to the menu item when the "Channel" toolbar is displayed.

### Toolbar "View" command

Use this command to display and hide the "View" toolbar, which includes buttons for the view commands, including:

"Primary panel maximized", "Show / hide assistant video panel", "Show / hide controller video panel", "Normal view", "Full screen with controls", "Full screen", "Full screen auto".

A checkmark appears next to the menu item when the "View" toolbar is displayed.

### Toolbar "Zoom" command

Use this command to display and hide the "Zoom" toolbar, which includes buttons for the view commands, including:

"Zoom 100%", "Zoom to fit view", "Zoom to fit width", "Zoom to fit height", "Zoom to fill view", "Zoom out (-)", "Zoom in (+)".

A checkmark appears next to the menu item when the "View" toolbar is displayed.

See Toolbar for help on using the toolbar.



## Status Bar command (View menu)

Use this command to display and hide the status bar, which describes the action to be executed by the selected menu item or pressed toolbar button, and keyboard latch state.

A checkmark appears next to the menu item when the status bar is displayed.

See Status Bar for help on using the status bar.

## Image menu commands

### Convert command

Use this command to convert image or video sequence from one format to another.

### Filter command

Use this command to filter image or video sequence.

### Capture command

Use this command to capture video sequence.

### PSNR command

Use this command to calculate PSNR - Peak Signal to Noise Ratio.

Value of PSNR is calculated for the two images in the video ports 1 and 3.

### Properties command

Use this command to display a dialog with description of image properties.

### Refresh Image command

Use this command to refresh images displayed in the video panels.

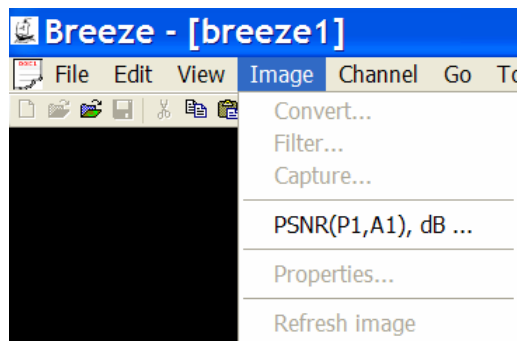

## Channel menu commands

The Channel menu offers the following commands.

### "Play primary channel" command

Use this command to enable or disable playing the primary channel (channel No.1).

If playing is enabled in the primary channel, then commands Start , Replay forth , Replay back , Replay step , Replay step back start playing or stepping the primary channel. If playing is disabled then the primary channel stays inactive when these commands are applied.

A checkmark appears next to the menu item when this command is selected.

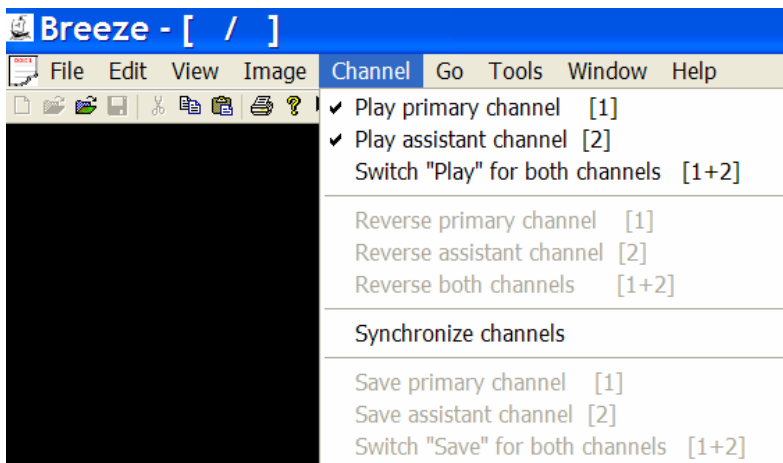

### "Play assistant channel" command

Use this command to enable or disable playing the assistant channel (channel No.2).

If playing is enabled in the assistant channel, then commands Start , Replay forth , Replay back , Replay step , Replay step back start playing or stepping the assistant channel. If playing is disabled then the assistant channel stays inactive when these commands are applied.

A checkmark appears next to the menu item when this command is selected.

### "Switch 'Play' for both channels" command

Use this command to switch "Enable playing" state for both channels, No.1 and No.2.

### "Reverse primary channel" command

Use this command to reverse replay direction for the primary channel (channel No.1).

A checkmark appears next to the menu item when this command is selected.

### "Reverse assistant channel" command

Use this command to reverse replay direction for the assistant channel (channel No.2).

A checkmark appears next to the menu item when this command is selected.

### "Switch 'Reverse direction' for both channels" command

Use this command to switch "Reverse direction" state for both channels, No.1 and No.2.

**"Synchronize channels" command**

Use this command to synchronize frame output for primary and assistant channels (channels No.1 and No.2).

A checkmark appears next to the menu item when this command is selected.

**"Save primary channel" command**

Use this command to save video from the primary channel (channel No.1).

A checkmark appears next to the menu item when this command is selected.

**"Save assistant channel" command**

Use this command to save video from the assistant channel (channel No.2).

A checkmark appears next to the menu item when this command is selected.

**"Switch "Save" for both channels" command**

Use this command to switch "Enable save" state for both channels (channels No.1 and No.2).

A checkmark appears next to the menu item when this command is selected.

## Go menu commands

The Go menu offers the following commands.

### "Start" command

Use this command to start playing a video sequence / sequences in one or two channels.

If channel is open, and playing is enabled then command "Start" initiate playing a video sequence.

If playing started successfully then item "Start" in the "Go" menu and in the pop up menu of a browser window becomes disabled (gray color). Button "Start" in the "Go" toolbar also become disabled.

At the same time items "Pause / Replay" and "Stop" in the "Go" menu and in the pop up menu of a browser window become enabled. Buttons "Pause / Replay" and "Stop" in the "Go" toolbar also becomes enabled.

If command "Start" has been successful the browser window changes its working mode from the "View" to "Play".

In the "Play" mode browser windows manages video sequence consisting of separate files same way as the single video file / stream consisting of multiple frames.

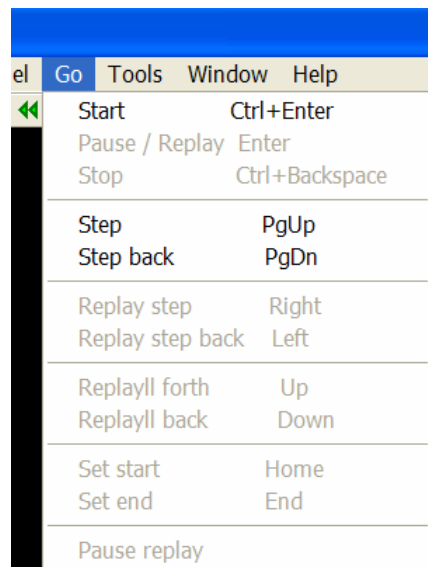

### "Pause / Replay" command

Use this command to pause playing a video sequence / sequences in one or two channels.

If playing was paused successfully then there are 3 main choices:

- Apply command "Start" to continue playing
- Apply command "Stop" to stop playing
- Apply one of "Replay" mode commands:
  - "Replay step"
  - "Replay step back"
  - "Replay"
  - "Replay back".

### "Stop" command

Use this command to stop playing a video sequence / sequences in one or two channels and to return browser window from the "Play" mode to the "View" mode.

If playing was stopped successfully then all items of "Go" menu and in the pop up menu of a browser window become disables, except item "Start". All buttons in the "Go" toolbar also become disabled except button "Start".

### "Step" command

Use this command to step forth within sequence of separate files placed inside one folder in the local computer, or on the intra or internet. During executing "Step" command browser window stays in the "View" mode.

If both channels, primary and assistant, are open then "Step" command advances video sequences in both channels. If in one channel the very last file has been reached already, before applying "Step" command, then only one channel is advanced by one step forth.

The order in which separate files or streams are loaded to the channels by the broser window corresponds to the sorting rules defined by the operating system for the folder where a sequence those separate files / streams is placed.

Command "Step" manages video files consisting of many frames similar to the files contaniing just one image. If file / stream is loaded to the channel by the "Step" command successfully, then the very first frame of the video sequence or single image of the picture file is displayed in the video panel.

### **"Step back" command**

Use this command to step back within sequence of separate files placed inside one folder in the local computer, or on the intra or internet. During executing "Step back" command browser window stays in the "View" mode.

If both channels, primary and assistant, are open then "Step back" command advances video sequences in both channels. If in one channel the very first file has been reached already, before applying "Step back" command, then only one channel is advanced by one step back.

The order in which separate files or streams are loaded to the channels by the broser window corresponds to the sorting rules defined by the operating system for the folder where a sequence of those separate files / streams is placed.

Command "Step back" manages video files consisting of many frames same way as the files contaniing just one image. If file / stream is loaded to the channel by the "Step back" command successfully, then the very first frame of the video sequence or single image of the picture file is displayed in the video panel.

### **"Replay step" command**

Use this command to step one frame forth within the replay cash buffer.

If both channels, primary and assistant, are open and playing for channels is enabled then "Replay step" command advances video sequences in both channels.

### **"Replay step back" command**

Use this command to step one frame back within the replay cash buffer.

If both channels, primary and assistant, are open and playing for channels is enabled then "Replay step back" command advances video sequences in both channels.

### **"Replay forth" command**

Use this command to replay forth frames within the replay cash buffer.

If both channels, primary and assistant, are open and playing for channels is enabled then "Replay forth" command replays sequences in both channels.

### **"Replay back" command**

Use this command to replay back frames within the replay cash buffer.

If both channels, primary and assistant, are open and playing for channels is enabled then "Replay back" command replays sequences in both channels.

### **"Set start" command**

Use this command to set current frame to the start of the replay cash buffer .

If both channels, primary and assistant, are open and playing for channels is enabled then "Set start" command advances sequences in both channels.

### **"Set end" command**

Use this command to set current frame to the very end of the replay cash buffer.

If both channels, primary and assistant, are open and playing for channels is enabled then "Set start" command advances sequences in both channels.

### **"Pause replay" command**

Use this command to pause replaying from the replay cash buffer.

If both channels, primary and assistant, are open and playing for channels is enabled then "Set start" command stops replaying in both channels.

## Tools menu commands

The Tools menu offers the following commands.

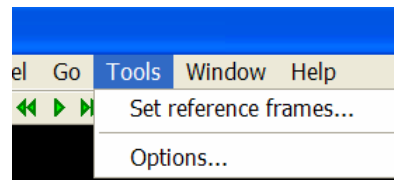

### "Set reference frames..." command

Use this command to open the "Reference frames" dialog where you can set start and stop reference frames used for playing a fragment of video sequence.

If channel is open, and playing for channels is enabled, and command "Start" is applied then video sequence begin to play. All frames placed within video sequence before start reference frame are skipped as fast as possible. Skipped frames are not displayed in the browser window.

Beginning from the start reference frame video sequence is played with normal speed and all frames are displayed in the browser window, until the stop reference frame is reached.

Playing is stopped when stop reference frame is reached.

Start and stop frames can also be set in the "Read stream" dialog. This dialog can be accessed via command "Options...".

### "Options..." command

Use this command to open "Options" dialogs .

This command is also available in the pop up menu of the browser window.

## Window menu commands

The Window menu offers the following commands, which enable you to arrange multiple views of multiple documents in the application window.

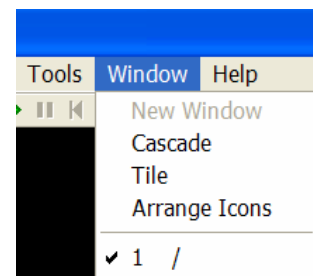

### New command

Use this command to open a new window with the same contents as the active window.

You can open multiple document windows to display different parts or views of a document at the same time. If you change the contents in one window, all other windows containing the same document reflect those changes. When you open a new window, it becomes the active window and is displayed on top of all other open windows.

### Cascade command

Use this command to arrange multiple opened windows in an overlapped fashion.

### Tile command

Use this command to arrange multiple opened windows in a nonoverlapped fashion

### Window Arrange Icons command

Use this command to arrange the icons for minimized windows at the bottom of the main window.

If there is an open document window at the bottom of the main window, then some or all of the icons may not be visible because they will be underneath this document window.

### 1, 2, ... command

Breeze displays a list of currently open document windows at the bottom of the Window menu. A checkmark appears in front of the document name of the active window. Choose a document from this list to make its window active.



## Help menu commands

The Help menu offers the following commands, which provide you assistance with this application.

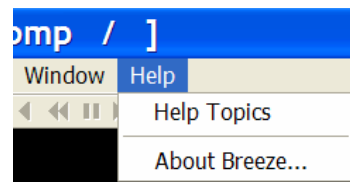

### Index command

Use this command to display the opening screen of help.

From the opening screen, you can jump to step-by-step instructions for using Breeze and various types of reference information.

Once you open help, you can click the Contents button whenever you want to return to the opening screen.

### About command

Use this command to display the copyright notice and version number of your copy of Breeze.

"About" dialog includes button "Visit" and text link. Click any of them to visit support web site of Breeze [www.DiscoveryBiz.net](http://www.DiscoveryBiz.net).

Breeze, Standard Edition and Professional Edition software packages include 30 days trial evaluation period.

Evaluation period starts immediately after installing a software. During this period functionality of software is same as in the activated software. To continue using software after evaluation period expires, software has to be activated with a License key. License key for downloaded software can be purchased on-line at [www.DiscoveryBiz.net](http://www.DiscoveryBiz.net).

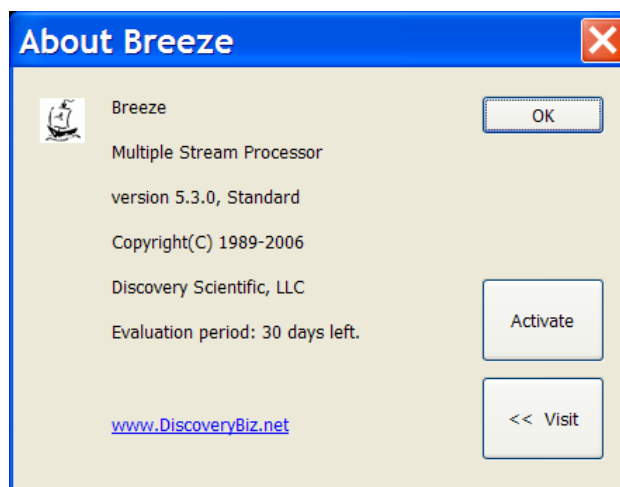

Activation license key is issued immediately after purchasing a product.

Subscription access key for packages with 12 months subscription for free download upgrades, is issued immediately after purchasing a product.

After license key is obtained, Breeze can be activated. During evaluation period "About" dialog box shows button "Activate". Click this button to open the "Breeze: product activation dialog". Enter license key in the activation dialog and then press button "Submit".

Before activation "About" dialog displays text information showing how many days are left for the trial evaluation. After successful activation "About" dialog displays activation license key. Button "Activate" is not shown in the "About" dialog box after activation.

## Pop up menu of a browser window

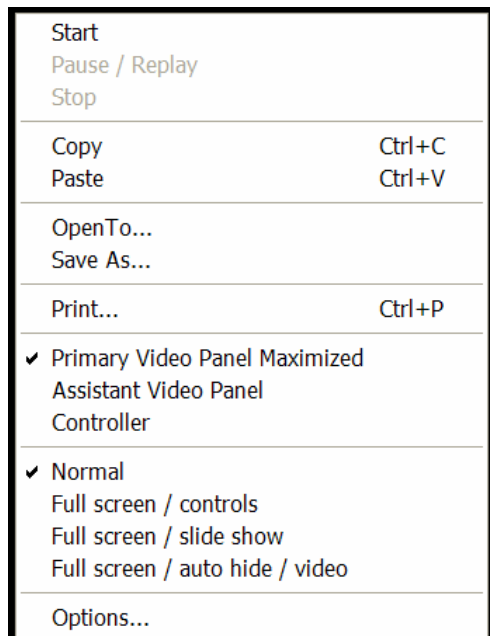

The Pop up menu of a browser window offers the following commands.

|                               |   |
|-------------------------------|---|
| Start                         | Start playing.  |
| Pause / Replay                | Pause play / Set replay mode.                         |
| Stop                          | Stop playing.   |
| Copy                          | Copies data from the document to the clipboard.       |
| Paste                         | Pastes data from the clipboard into the document.     |
| Open                          | To Opens an existing document to the channel.         |
| Save                          | As Saves an opened document to a specified file name. |
| Print                         | Prints a document.                                    |
| Primary Video Panel Maximized | Maximize or minimize primary video panel.             |
| Assistant Video Panel         | Show or hide assistant video panel.                   |
| Controller                    | Show or hide controller panel.                        |
| Normal                        | Normal screen view.                                   |
| Full screen with controls     | Full screen view with controls/ slides and video.     |
| Full screen                   | Full screen view / slides and video.                  |
| Full screen auto              | Full screen view auto hide / video.                   |
| Options...                    | Open "Options" dialogs                                |

## 4. Toolbars

Toolbars are displayed across the top of the application window, below the menu bar. They provide quick mouse access to many tools used in Breeze.

To hide or display the toolbar, click **Toolbar** from the **View** menu, and then select toolbar you want to show or hide.

Another way to show or hide toolbars is to place mouse cursor over the toolbar panel and to click right button of a mouse. A drop down list of toolbars names will appear over toolbar panel. Click the toolbar you want to show of hide.

When Breeze main window is minimized some toolbars will display only part of all available buttons. In that case on the right side of toolbar a chevron ">>" icon appears, indicating that there are more toolbar buttons available than it is displayed currently. To access hidden buttons click chevron icon ">>". A drop down list of hidden buttons together with definitions of commands will appear. Click the button corresponding to the command you need.

Currently Breeze supports the following toolbars:

|          |  |
|----------|--|
| Standard | Most frequently used commands  |
| Go Main  | commands used by the browser window in the "Play" mode                   |
| Channel  | Commands controlling state of channels                                   |
| View     | Commands controlling configuration of video panels in the browser window |
| Zoom     | Commands controlling zooming of images displayed in the browser window   |

### **"Standard" toolbar**

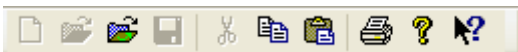

The Standard toolbar offers the following commands:

|       |   |
|-------|---|
| New   | Creates a new document.   |
| Open  | Opens an existing document.                                     |
| Open  | To Opens an existing document to the channel.                   |
| Save  | Saves an opened document using the same file name.              |
| Cut   | Deletes data from the document and moves it to the clipboard.   |
| Copy  | Copies data from the document to the clipboard.                 |
| Paste | Pastes data from the clipboard into the document.               |
| Print | Prints a document.  |
| Help  | Topics Offers you an index to topics on which you can get help. |
| About | Displays the version number of this application.                |

## "Go" toolbar



The Go toolbar offers the following commands:

|                   |   |
|-------------------|---|
| Stop              | Stop playing                                    |
| Step back         | Step back                                       |
| Start             | Start playing                                   |
| Step              | Step forth.                                     |
| Pause / Replay    | Pause play / Set replay mode                    |
| Set start         | Set current frame to the start of the buffer    |
| Replay back       | Replay back                                     |
| Replay step back  | Step back in replay mode                        |
| Pause replay      | Pause replaying                                 |
| Replay step forth | Step forth in replay mode                       |
| Replay forth      | Start forth in replay mode                      |
| Set end           | Set current frame to the very end of the buffer |

## "Channel" toolbar



The Channel toolbar offers the following commands:

|                                       |  |
|---------------------------------------|--|
| Play primary channel [1]              | Enable/Disable playing primary channel [1].                  |
| Play assistant channel [2]            | Enable/Disable playing assistant channel [2].                |
| Switch "Play" for both channels [1+2] | Switch "Enable playing" state for both channels.             |
| Reverse primary channel [1]           | Reverse replay direction for primary channel [1].            |
| Reverse assistant channel [2]         | Reverse replay direction for assistant channel [2].          |
| Reverse both channels [1+2]           | Reverse replay direction for both channels.                  |
| Synchronize channels                  | Synchronize frame output for primary and assistant channels. |
| Save primary channel [1]              | Save video from the primary channel [1].                     |
| Save assistant channel [2]            | Save video from the assistant channel [2].                   |
| Switch "Save" for both channels [1+2] | Switch "Enable saving" state for both channels.              |

## "View" toolbar



The View toolbar offers the following commands:

|                               |   |
|-------------------------------|---|
| Primary Video Panel Maximized | Maximize or minimize primary video panel.         |
| Assistant Video               | Panel Show or hide assistant video panel.         |
| Controller                    | Show or hide controller panel.                    |
| Normal                        | Normal screen view.                               |
| Full screen with controls     | Full screen view with controls/ slides and video. |
| Full screen                   | Full screen view / slides and video.              |
| Full screen auto              | Full screen view auto hide / video.               |

## "Zoom" toolbar



The Zoom toolbar offers the following commands:

|            |                                      |
|------------|--------------------------------------|
| Zoom 100%  | Zoom to 100%.                        |
| Fit view   | Zoom to fit image into view.         |
| Fit width  | Zoom to fit width.                   |
| Fit height | Zoom to fit height.                  |
| Fill view  | Zoom to fill entire view with image. |
| Zoom plus  | Zoom in view (+).                    |
| Zoom minus | Zoom out view (-).                   |

## Status Bar

The status bar is displayed at the bottom of the Breeze window. To display or hide the status bar, use the Status Bar command in the View menu.

The left area of the status bar describes actions of menu items as you use the arrow keys to navigate through menus. This area similarly shows messages that describe the actions of toolbar buttons as you press them, before releasing them. If after viewing the description of the toolbar button command you wish not to execute the command, then release the mouse button while the pointer is off the toolbar button.

The right areas of the status bar indicate which of the following keys are latched down:

| Indicator | Description                          |
|-----------|--------------------------------------|
| CAP       | The Caps Lock key is latched down.   |
| NUM       | The Num Lock key is latched down.    |
| SCRL      | The Scroll Lock key is latched down. |



## 5. "Options" dialogs

"Options" dialog boxes provides you the means to configure and monitor a number important features of the Breeze.

The majority of "Options" dialogs are available via the main menu item "Options...". That item is also available in the pop up menu of a browser window .

Several options dialogs are accessed via the file manager dialogs.

Currently Breeze supports the following "Options" dialogs:

|                    |  |
|--------------------|--|
| General            | This dialog displays general information about Breeze, including its edition and version.  |
| Channels           | This dialog display information about channels.  |
| Read stream        | This dialog allows you to enable / disable reading of input streams and set their parameters.  |
| Save sequence      | This dialog allows you to enable / disable "Save" operations for processed streams and set parameters of "Save" operations.                              |
| Capture image      | This dialog allows you to enable / disable "Save captured image" operation for processed streams and set parameters of "Save captured image" operations. |
| Video              | This dialog allows you to specify parameters of Breeze during playing a video.   |
| Set "Save" paths   | This dialog allows you to select a path, file or folder, where video sequence will be saved.   |
| File formats: YUV  | This dialog allows you to specify parameters of YUV format file / stream.  |
| File formats: JPEG | This dialog allows you to specify parameters of JPEG file / stream format.   |
| File formats: PNG  | This dialog allows you to specify parameters of PNG file / stream format.  |
| Reference frames   | This dialog allows you to set start and stop reference frames used for playing a fragment of video sequence.   |

## "General" options dialog box

This dialog displays general information about Breeze, including its edition and version.

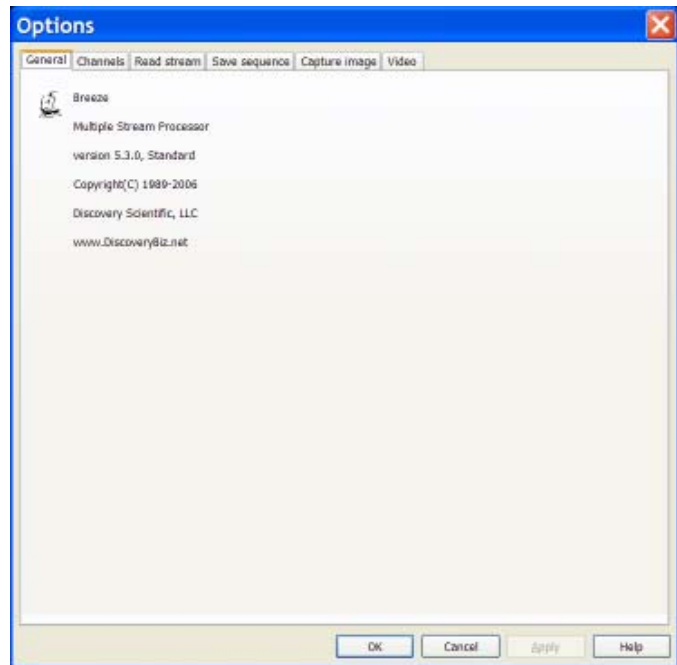

## "Channels" options dialog box

This dialog display information about channels.

Upper info panel displays information about primary channel. Bottom info pane displays information about assistant channel.

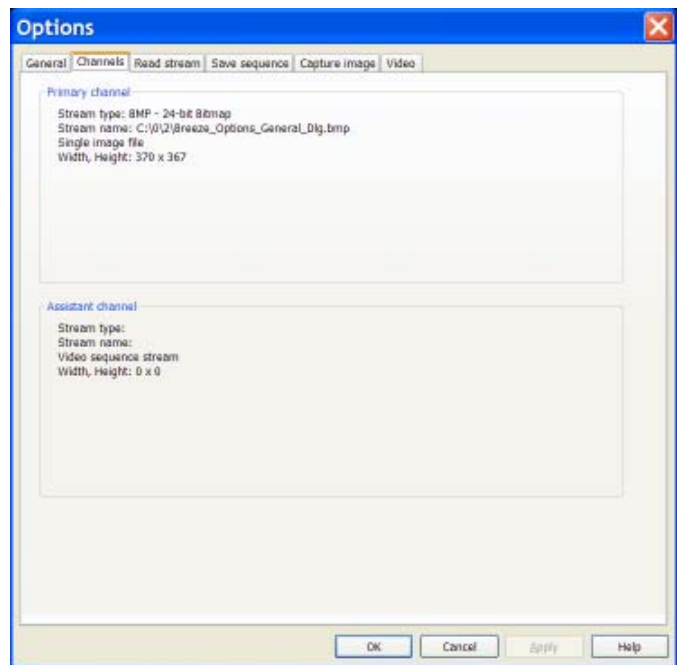

## "Read stream" options dialog box

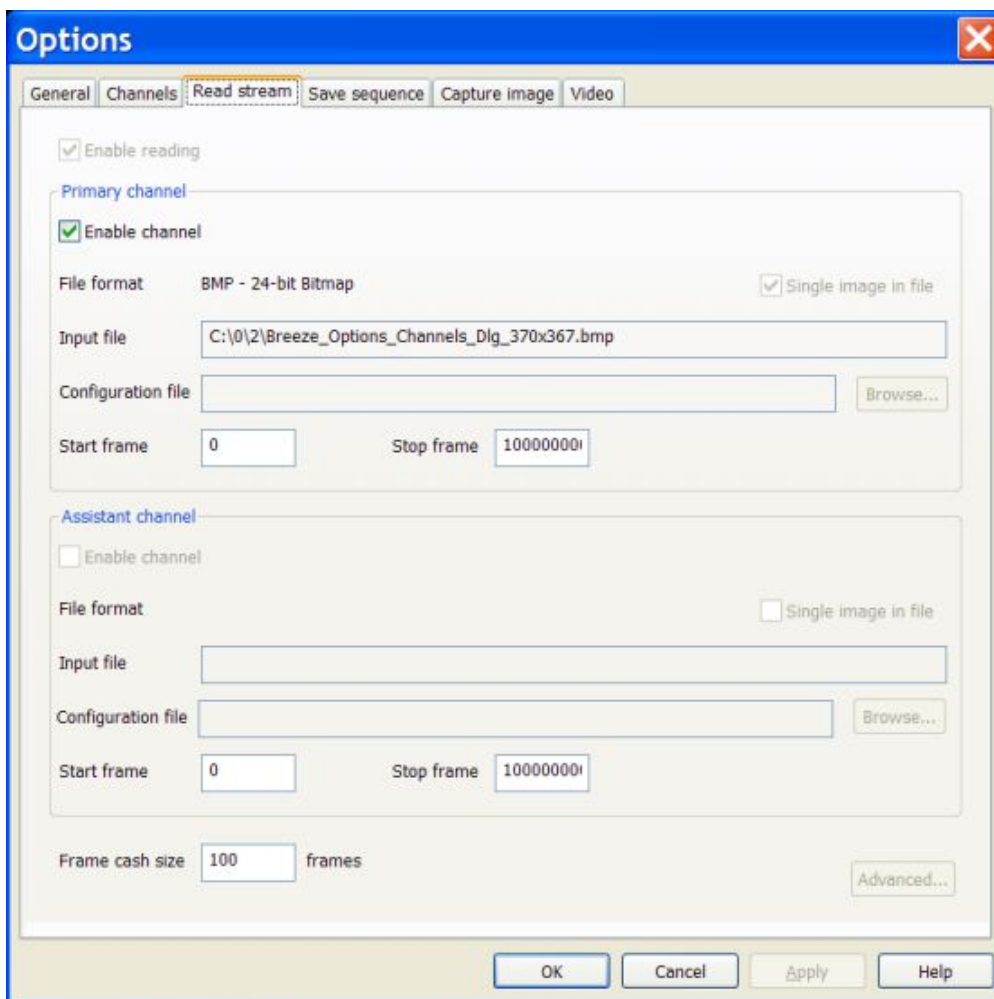

This dialog allows you to enable / disable reading of input streams and set their parameters.

There are two main panels in this dialog, upper panel and lower panel. Upper panel is associated with the primary channel, and lower panel is associated with the assistant channel. At the very bottom of the dialog there are also additional controls associated with both channels.

The following options are available in this dialog:

### "Enable reading" check box

Enables / disables reading of both channel independently on whether individual channels are enabled or not.

### "Enable channel" check box

Enable / disable reading for the individual channel, primary or assistant.

**"File format" text box**

This field shows a format of the stream open to the channel.

**"Single image in file" check box**

Files / streams of some types can be processed by two ways:

- As a file with just single image in file, or
- As a video sequences consisting of many images (frames) saved in one file.

One popular example is YUV files.

"Single image in file" check box allows to specify how to process that sort files / streams.

This check box is enabled only for the file formats wich can be used both ways, as video and as single image file.

Breeze disables this check box for file / stream formats which can be processed only as a video sequence or as a file with just single image in it. In that case check box shows the type of file / stream open to the channel.

**Configuration file**

If this field is enabled it allows to select configuration file specifying parameters of the channel and the stream open to the channel.

**"Start frame" and "Stop frame" edit boxes**

This dialog allows you to set start and stop reference frames used for playing a fragment of video sequence.

If channel is open, and playing for channels is enabled, and command "Start" is applied then video sequence begin to play. All frames placed within video sequence before start reference frame are skipped as fast as possible. Skipped frames are not displayed in the browser window.

Beginning from the start reference frame video sequence is played with normal speed and all frames are displayed in the browser window, until the stop reference frame is reached.

Playing is stopped when stop reference frame is reached.

To play very long video sequence without stops, set stop frame to some very big number. Default value set by Breeze is 1,000,000,000. That value allows to play video at the frame rate 30 frames per second during 1 year and 3 months without stops.

Start and stop frames can also be set in the "Reference frames" dialog available via the item Set reference frames... of the "Tools" menu.

**"Frame cash size" edit box**

Use this edit box to set number of frames in the frame cash buffers for primary and assistant channels.

Each channel has its independent frame cash buffer. Both frame cash buffers have the same number of frames.

During playing video sequences frames are collected in the frame cash buffers until buffers become filled completely. After that, the new coming frames replace the very last ones. Collected frames can later be replayed from the frame cash buffers.

## "Save sequence" options dialog box

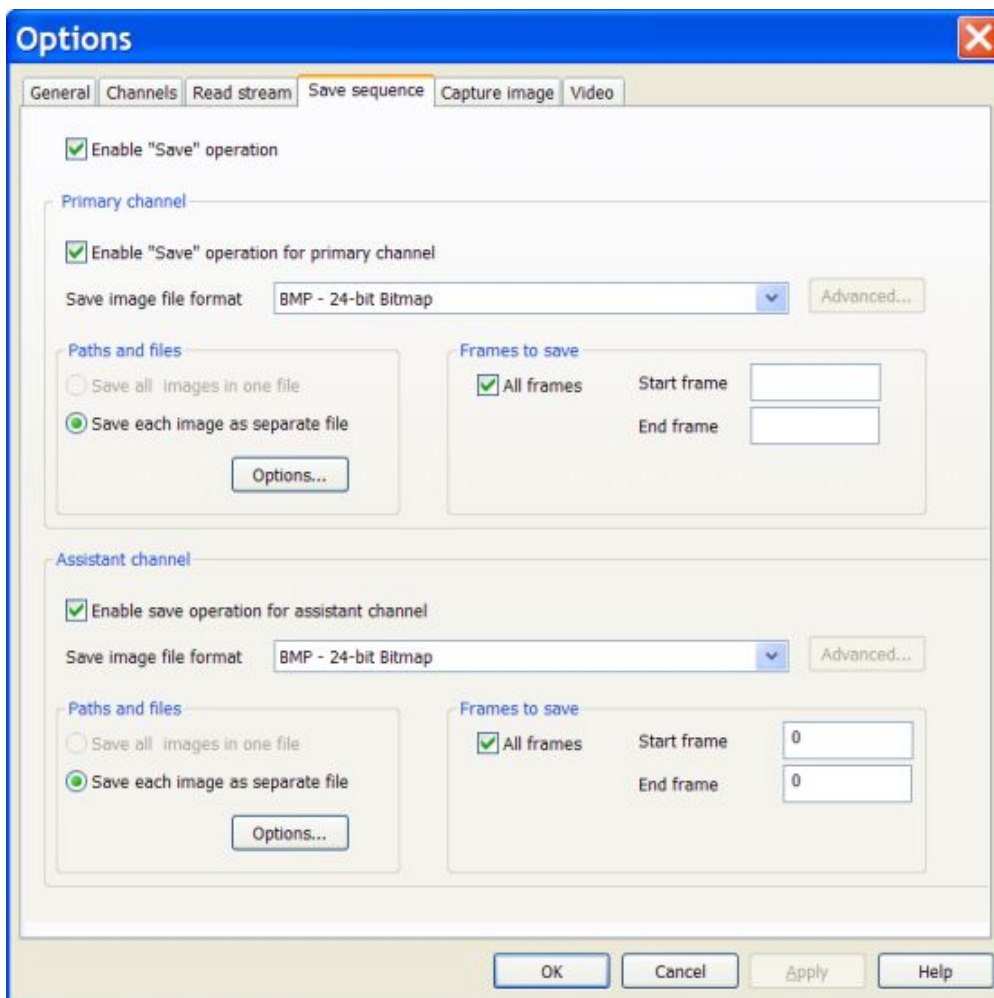

This dialog allows you to enable / disable "Save" operations for processed streams and set parameters of "Save" operations.

There are two panels in this dialog, upper panel and lower panel. Upper panel is associated with the primary channel, and lower panel is associated with the assistant channel.

The following options are available in this dialog:

### "Enable 'Save' operation" check box

Enables / disables "Save" operations for both channels, independently on whether those operations for individual channels are enabled or disabled (grayed).

### "Enable 'Save' operation for primary / assistant channel" check box

Enable / disable "Save" operations for the individual channel, primary or assistant.

### **"Save image file format" combo box**

Click the arrow on the right side of this combo box to open a list of all available file formats which can be used to save video sequence from the active channel.

There are two sub groups of file formats included in this list:

- File formats which do not require additional specification, like Microsoft Bitmap (\*.bmp)
- File formats which may require additional specification, like JPEG, PNG, YUV etc.

If you selected file format of the first type then button "Advanced...", placed to the right of the "Save image file format" combo box, is disabled (grayed). Disabling that button means that you do not need enter any additional information.

If you selected file format of the second type then button "Advanced...", placed to the right of the "Save image file format" combo box, is enabled. If that button is enabled, it means that you may need to enter additional information about selected file format.

For example, JPEG and PNG file format may require setting a level of compression, and internal image sub format; YUV file format may require specifying how YUV images will be saved, in one file with multiple images, or in multiple files with single image in each file, etc.

### **"Paths and files" group box**

In this group box you have to specify a full path to the file / files where video data from the channel will be saved.

### **"Save all images in one file" and "Save each image as separate file" radio buttons**

Select single or multiple file format for the "Save" operation.

If file format selected in the combo box "Save image file format" allows to save images from the channel in two ways, as:

- All images are saved in one file,
- Each image is saved as a separate file,

then both radio buttons are enabled. Click a required radio button to select the variant you need.

If file format selected in the combo box "Save image file format" allows to save images from the channel in just one way, then Breeze disables (grays) one of two radio buttons, leaving enabled the one which corresponds to the selected file format.

### **"Options..."**

Click this button to open the dialog where you can specify a full path to the file / files where video data from the channel will be saved. This data has to be specified at least once. Otherwise "Save" operations will be disabled.

### **"Frames to save" group box**

In this group box you may set a range of frames which have to be saved from the channel.

### "All frames" check box

Check this box to save all frames from the channel.

If this box is checked then all frames will be saved, and values of "Start frame" and "End frame" are ignored.

### "Start frame" and "End frame" edit boxes

In these edit boxes you can set the range of frames which have to be saved.

Values of "Start frame" and "End frame" are taken in account only if check box "All frames" is unchecked, otherwise values of start and end frames are ignored.

Frames are saved to the file / files if the following conditions are met:

- "Save" operation is enabled for the channel,
- Video sequence is playing,
- Check box "All frames" is unchecked,
- Order number of the currently displayed frame is between values of "Start frame" and "End frame".

### Remarks

"Save sequence" operation allows to save sequences from the channels in the "Play" mode. Sequence can be captured in a real time from the input streams during direct "Play" operations. Played sequences can be save from the both, primary or assistant, channels concurrently, or from the one channel only.

The fastest way to control "Save sequence" operations during direct "Play" operation is to click "Enable / Disable playing" buttons in the "Go" toolbar.

### Convert file / stream from one format to another

If file format of the input sequence is different from the file format of the saved (output) sequence then the "Save sequence" operation is essentially a "File conversion" operation.

Breeze offers a big number of file conversion variants. See the topic supported video and image formats for more detailed information.

To perform a file conversion operation it is required:

1. Select input sequence; video file or sequence of separate image files,
2. Specify parameters of a "Save sequence" operation, including file format of the file / files where data from the channel will be saved into,
3. Enable "Save sequence" operation, in the "Save sequence" options dialog,
4. Start playing a channel / channels.

Use buttons in the "Go" toolbar for a faster control of a "File conversion" operations.

## "Capture image" options dialog box

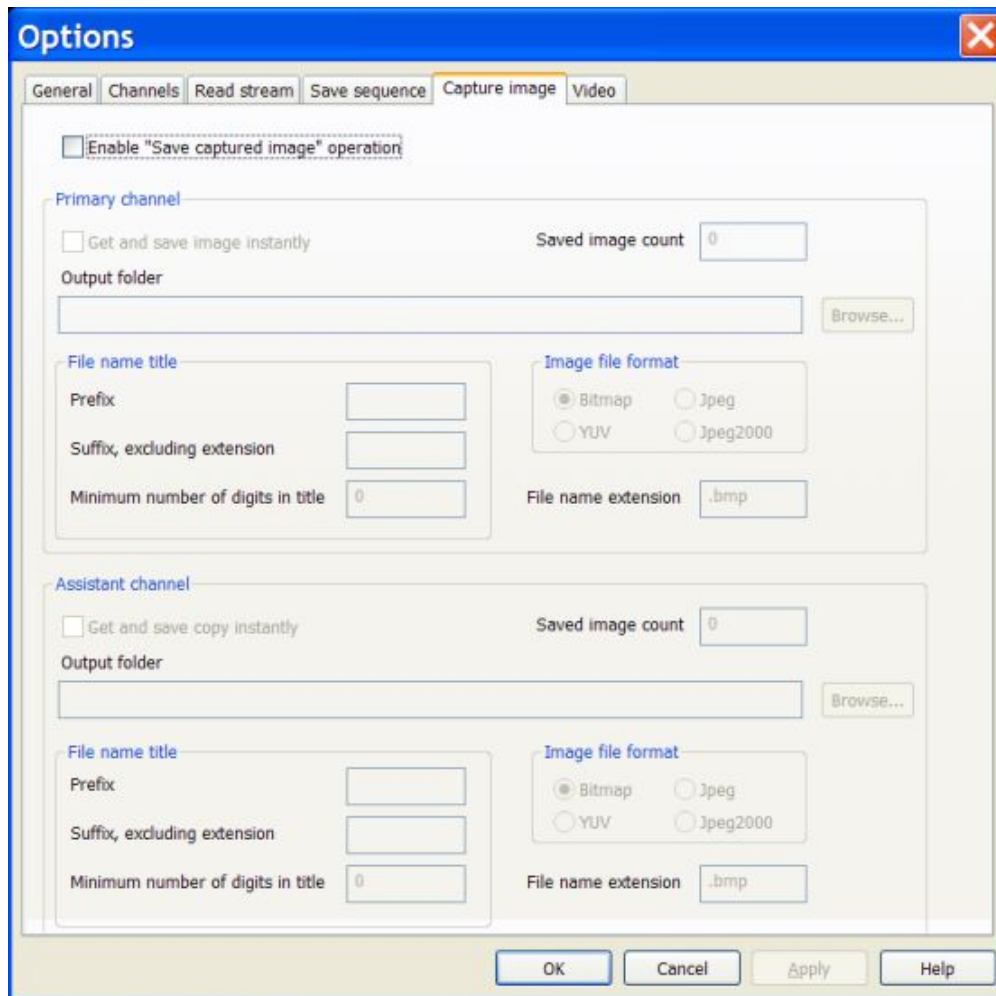

This dialog allows you to enable / disable "Save captured image" operation for processed streams and set parameters of "Save captured image" operations.

The following options are available in this dialog:

### "Enable 'Save save captured image" operation" check box

Enables / disables "Save captured image" operations for both channels.

### "Get and save image instantly" check box

Enable / disable instant saving of image from the main video output port to the "pocket" video output port, and then to the file / files on the disk.

If this check box is unchecked then captured images is just saved to the "pocket" video port

### "Save image count" edit box

This edit box allows you to set a start number which will be used as a reference for counting captured images. It can be reset any time to a new number.



**"Output folder" edit box**

In this edit box you have to specify full path to the folder where files containing captured image will be saved.

You can do it manually or in the "Select folder" file manager dialog . To open "Select folder" dialog click button "Browse..." placed to the right of the "Output folder" edit box.

**"File name title" group box**

In this group box you have to specify components of file name title. That title will be used in the file name of saved captured images.

**"Prefix" edit box**

Specify in this edit box a prefix (the very first part) of the file name title.

**"Suffix" edit box**

Specify in this edit box a suffix (the very last part) of the file name title.

**"Minimum number of digits in title" edit box**

Specify in this edit box a minimum number of digits in the digital root (middle part) of the file name title.

**"Image file format" group box**

In this group box you have to specify a format of files where captured images will be saved into.

**"File name extension" edit box**

Use this edit box if you want to specify a file name extension different from the default file name extension defined for the selected file format.

**Remarks**

"Capture image" operation allows to capture images from the channels in the "Play" mode. Images can be captured in real time from the input streams during direct "Play", or during "Replay" from the frame cache buffers.

"Capture image" operation is initiated by the clicking button "Get" in the controller panel of a browser window. There two "Get" buttons in the controller panel; upper one is associated with the primary channel, and lower one is associated with the assistant channel.

When button "Get" is clicked, image from the main video output port of the channel is saved to the "pocket" video output port of the channel.

Image from the "pocket" video port can also be instantly saved to the file / files on the disk, if "Get and save image instantly" check box associated with the selected channel is checked. If this check box is unchecked then captured image is just saved to the "pocket video" port. Captured image kept in the "pocket" video port can any time be saved to the file by clicking button "Save". There two "Save" buttons in the controller panel; upper one is associated with the primary channel, and lower one is associated with the assistant channel.

Table below shows main and "pocket" video ports associated with the primary and assistant channels.

| Channel   | Main video output port No. | "Pocket" video output port No. |
|-----------|----------------------------|--------------------------------|
| Primary   | 1                          | 2                              |
| Assistant | 3                          | 4                              |

If each captured image is saved to the separate file then names of files are sequentially numbered and ordered by the Breeze. Title of the saved file name includes prefix, digital root and suffix. Digital root is a fixed length text consisting of the decimal digit characters. Root is made by the converting an order number of the captured frame into text. During mass "Capture image" operations prefix and suffix are constant for all saved files, but digital root is changing according to the order number of the captured image.

There are two main panels in "Capture image" dialog, upper panel and lower panel. Upper panel is associated with the primary channel, and lower panel is associated with the assistant channel.

## "Video" options dialog box

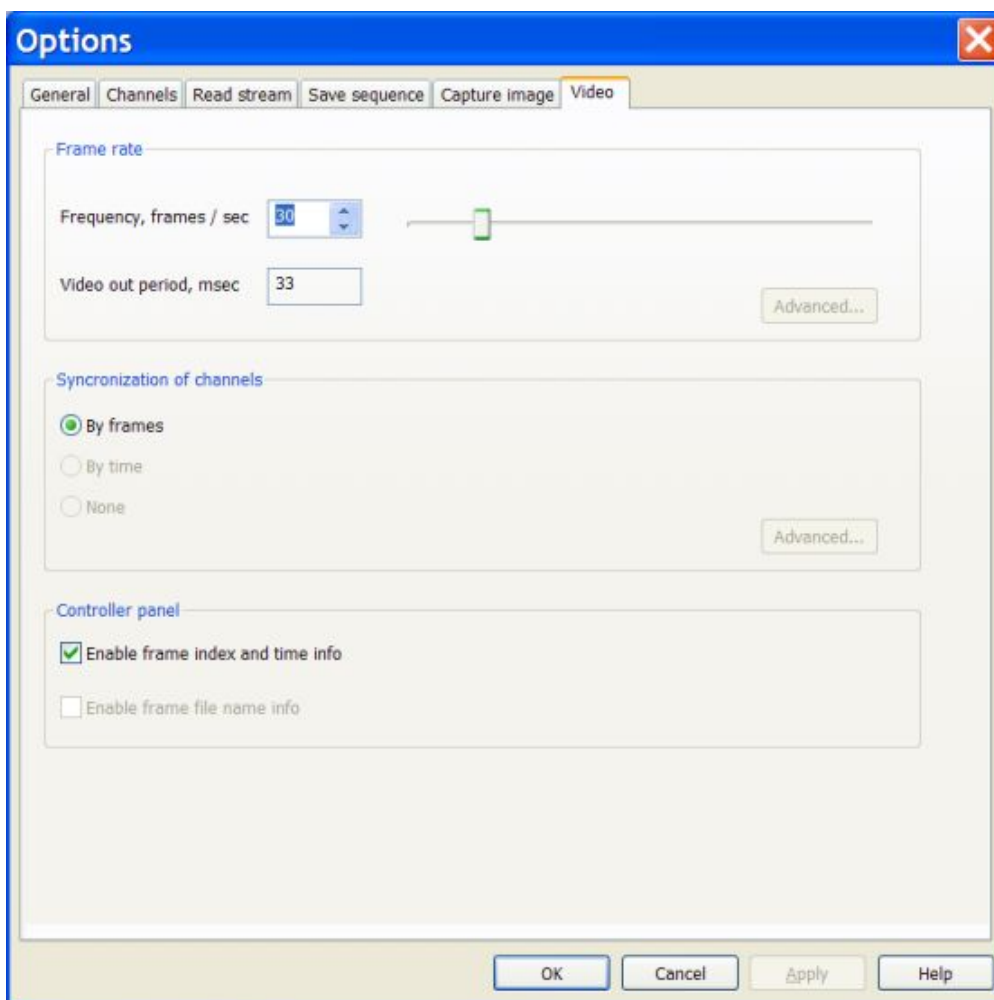

This dialog allows you to specify parameters of Breeze during playing a video.

These parameters are applied when Breeze is in the "Play" mode, and executes "Play" and "Replay" operations.

The following options allow you to specify video play parameters:

### "Frequency, frames / sec in" combo box

Specify in this field a maximum frame rate (frequency) of video play / replay operations.

This frame rate can further be reduced from the maximum value to zero by setting the "Play" slider in the controller pane of a browser window.

### "Video out period, msec" text box

This read only text box shows length in milliseconds ( 0.001 of second) of a video output period (length of time during which one frame is processed).

**"Synchronization of channels" group box**

Specifies in this group box how concurrently played video streams in the primary and assistant channel have to be synchronized.

**"Controller panel" group box**

Specify in this group box the parameters of a video info output in the controller panel.

**"Enable frame index and time info" check box**

Enable / disable real time displaying of a frame index and time info in the controller panel during "Play" and "Replay" operations.

Displaying frame indexes and time info for each frame when video is playing, may slow down total frame rate noticeably, and especially on the computers equipped with a low speed CPU.

It may be useful to disable displaying these parameters in the controller panel during playing a real time video.

On the other hand, knowing indexes of frames and time info for each frame can be very useful during replaying a video from the frame cash buffers. Therefore it may be useful to enable displaying these parameters in the controller panel during replaying a video from the buffers.

## "Set 'Save' paths" options dialog box

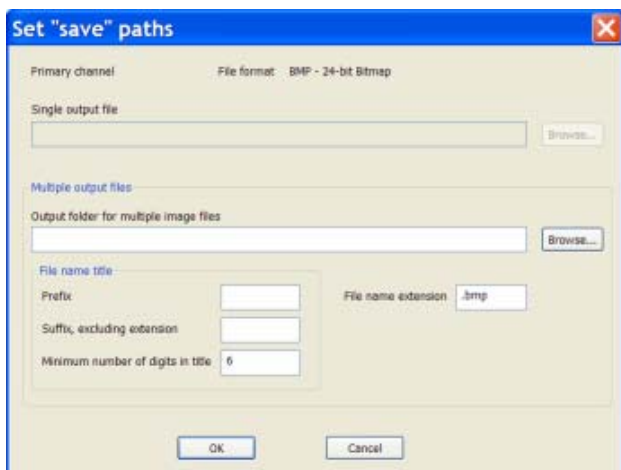

This dialog allows you to select a path, file or folder, where video sequence will be saved. The following options allow you to specify a path:

### "Info" text box

At the very top of the dialog there is a read only "info" text box. In that box you may see information inherited from the "Options" dialog "Save sequence":

- Name of the channel where "Save" operation is implemented,
- Format of file / files where video sequence will be saved to.

### "Single output file" edit box

In this edit box you may enter a path to the file where video sequence will be saved to. You can type path name manually or you can select it in the file dialog. To open a file dialog click the button "Browse..." placed to the right of the "Single output file" edit box.

### "Multiple output files" group box

In this group box you may specify the path to the folder where video sequence will be saved in the multiple files with just one image in each file.

### "Output folder for multiple image files" edit box

In this group box you may specify the path to the folder where video sequence will be saved. You can type path name manually or you can select it in the file dialog. To open a file dialog click the button "Browse..." placed to the right of the "Output folder for multiple image files" edit box.

### "File name title" group box

In this group box you have to specify components of file name title. That title will be used in the file name of saved captured images.

**"Prefix" edit box**

Specify in this edit box a prefix (the very first part) of the file name title.

**"Suffix" edit box**

Specify in this edit box a suffix (the very last part) of the file name title.

**"Minimum number of digits in title" edit box**

Specify in this edit box a minimum number of digits in the digital root (middle part) of the file name title.

**"File name extension" edit box**

Use this edit box if you want to specify a file name extension different from the default file name extension defined for the selected file format.

**Remarks**

There are two variants of "Save" path, "Save" file and "Save" folder.

If all frames of video sequence are saved in the single file, then you have to specify a full path to that "Save" file. If each frame of video sequence is saved in a separate file in the certain folder, then you have to specify a full path to that "Save" folder.

The concrete variant of a "Save" operation, "Save all images in one file" or "Save each image as separate file", is selected in options dialog "Save sequence".

This dialog "Set 'Save' path" is invoked from the "Save sequence" dialog, after variant of "Save" path is selected. Therefore Breeze "knows" which variant to use, and formats the fields of "Set 'Save' path" dialog correspondingly.

If video sequence will be saved in the single file then edit box "Single output file" is enabled and, at the same time, all controls in the group box "Multiple output files" are disabled (grayed). And "vice versa", if each frame of video sequence will be saved in a separate file in the specified folder, then all controls in the group box "Multiple output files" are enabled, and, at the same time, edit box "Single output file" is disabled.

## "File formats: YUV" options dialog box

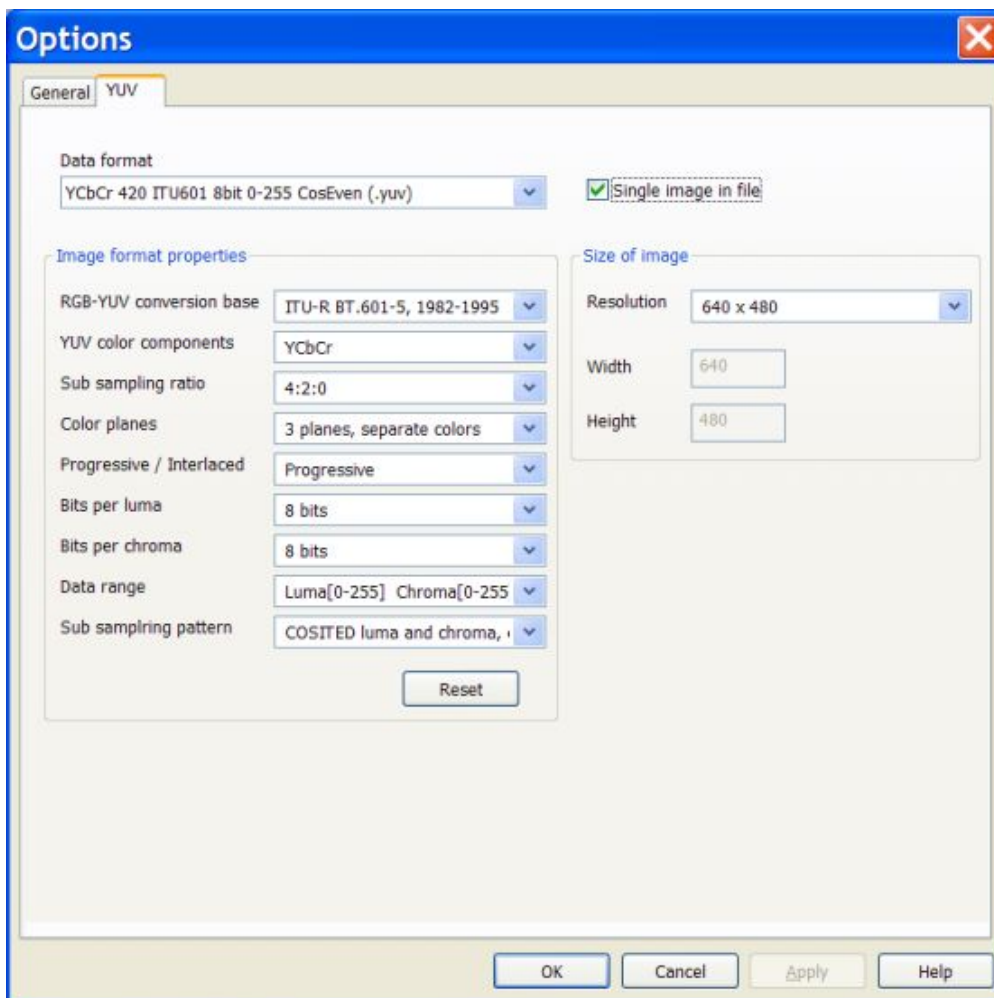

This dialog allows you to specify parameters of YUV format file / stream.

For additional information about YUV formats please visit section FAQ (Frequently Asked Questions) at the Breeze support web site [www.DiscoveryBiz.Net](http://www.DiscoveryBiz.Net)

The following options allow you to specify YUV file / stream:

### "Data format" combo box

This combo box allows specifying YUV image format entirely.

If you know exactly the name of required format then you can select it from the full list in this combo box.

The list of displayed YUV formats depends on the filter values selected in the other combo boxes, placed under "Data format" combo box.

All available formats are displayed in the list when values of filters are set to "Any" value. It means that YUV format is specified in general only.

To make specification more definite, filters have to be set to the concrete values. As a result, a list of YUV formats displayed in the "Data format" combo box becomes shorter. The more filters are set to the definite values, the more precisely YUV format is defined.

#### **"RGB-YUV conversion base" combo box**

This combo box specifies an RGB-YUV conversion base.

Conversion base is defined, first of all, by the formulae coefficients. Breeze supports major international standards specifying RGB - YUV conversion.

#### **"YUV color components" combo box**

This combo box specifies YUV color components as they are defined in the concrete YUV color spaces.

#### **"Sub sampling ratio" combo box**

This combo box specifies sub sampling ratio for chroma color components.

#### **"Color planes" combo box**

This combo box specifies a structure of color planes and how individual colors of each pixel placed in the color planes.

There are two major variants, planar and interleaved. In the first variant data describing a color component are saved in one continuous array. For 3 color components 3 color planes are used. In the second variant all color components describing one pixel are kept together, one after another. In this variant only one interleaved color plane is used.

#### **"Progressive / Interlaced" combo box**

This combo box specifies a frame scan structure.

Entire horizontal line of pixels is called image scan line. Hardware equipment usually scans images line by line; in a whole scan line units. There are two major variants of scanning image, progressive and interlaced.

In the progressive scan scheme an image is scanned entirely, line by line.

In the interlaced scheme an image is scanned in two stages, even and odd. At the even stage all even lines of image are scanned; then at the odd stage all odd lines are scanned. These two sub groups of scan lines are usually saved separately. When image is restored for displaying to a user, scan lines from the even and odd sub groups are joint in one image by the special procedure called "deinterlacing"

#### **"Bits per luma" combo box**

This combo box specifies how many bits per luma color component is used to represent data for one pixel.

#### **"Bits per chroma" combo box**

This combo box specifies how many bits per chroma color component is used to represent data for one pixel.



**"Data range" combo box**

This combo box specifies the range of values used to represent luma and chroma withing limits of minimum and maximum values.

For example, if 8 bits is reserved for luma and chroma color components, then the minimum value is 0, and maximum value is 255. At the same time concrete YUV format may require using more narrow range of values, for example 16 - 235 for luma, 16 - 240 for both chromas.

**"Sub sampling pattern" combo box**

This combo box specifies a pattern of sub sampled chroma components.

**"Single image in file" combo box**

This combo box specifies how a sequence of YUV images is organized, as a one file / stream with multiple images in it, or as a multiple file with the single image in each file.

**"Size of the image" group box**

This group box allow you to specify size (resolution) of the YUV image.

**"Resolution" combo box**

This combo box allows you to make a selection from the list of major standard resolutions, or to specify custom sizes of the image.

**"Width" and "Height" edit boxes**

These edit boxes allow you to specify width and height of the image if you have selected a "custom resolution" in the "Resolution" combo box.

**Remarks**

YUV files / streams are specified by the following main parameters:

1. YUV image format itself:
  - RGB - YUV conversion base (formulae coefficients)
  - Type of YUV color components
  - Sub sampling ratio
  - Structure of color planes, planar or interleaved
  - Frame scan structure, progressive or interlaced
  - Luma bit depth
  - Chroma bit depth
  - Data range for each color component
  - Sub sampling pattern
2. Size of YUV image, width and height
3. Number of images in file / stream, single or multiple).

## What is YUV?

YUV color model imitates a human vision. Humans are able to recognize (discern) the contents of a color RGB (Red / Green / Blue) image presented in the two main forms, as an original RGB color image or as a gray (black / white) image.

Historically, YUV color space was developed to provide compatibility between color and black /white analog television systems. YUV color image information transmitted in the TV signal allows proper reproducing an image contents at the both types of TV receivers, at the color TV sets as well as at the black / white TV sets.

Term YUV itself is not defined precisely in the technical and scientific literature. In general it designates a whole family of so called luminance / chrominance color spaces. The best way to avoid ambiguity associated with the term YUV is to refer to the concrete variant of YUV colors space well defined in the internationally recognized standard documents.

YCbCr color space is defined in the ITU-R BT.601-5 and ITU-R BT.709-5 standards of ITU (International Telecommunication Union). These documents define YCbCr as a color space for digital television systems. These documents give concrete definitions for coefficients of conversion between RGB and YCbCr color spaces, for normalization and quantization of digital signals. A majority of parameters defined for the digital YCbCr color space remains the same for the YPbPr color space used in the analog television systems. YCbCr and YPbPr color spaces are closely related.

Individual color components of YCbCr color space are luma Y, chroma Cb and chroma Cr. Chroma Cb corresponds to the U color component, and chroma Cr corresponds to the V component of a general YUV color space.

## "File formats: JPEG" options dialog box

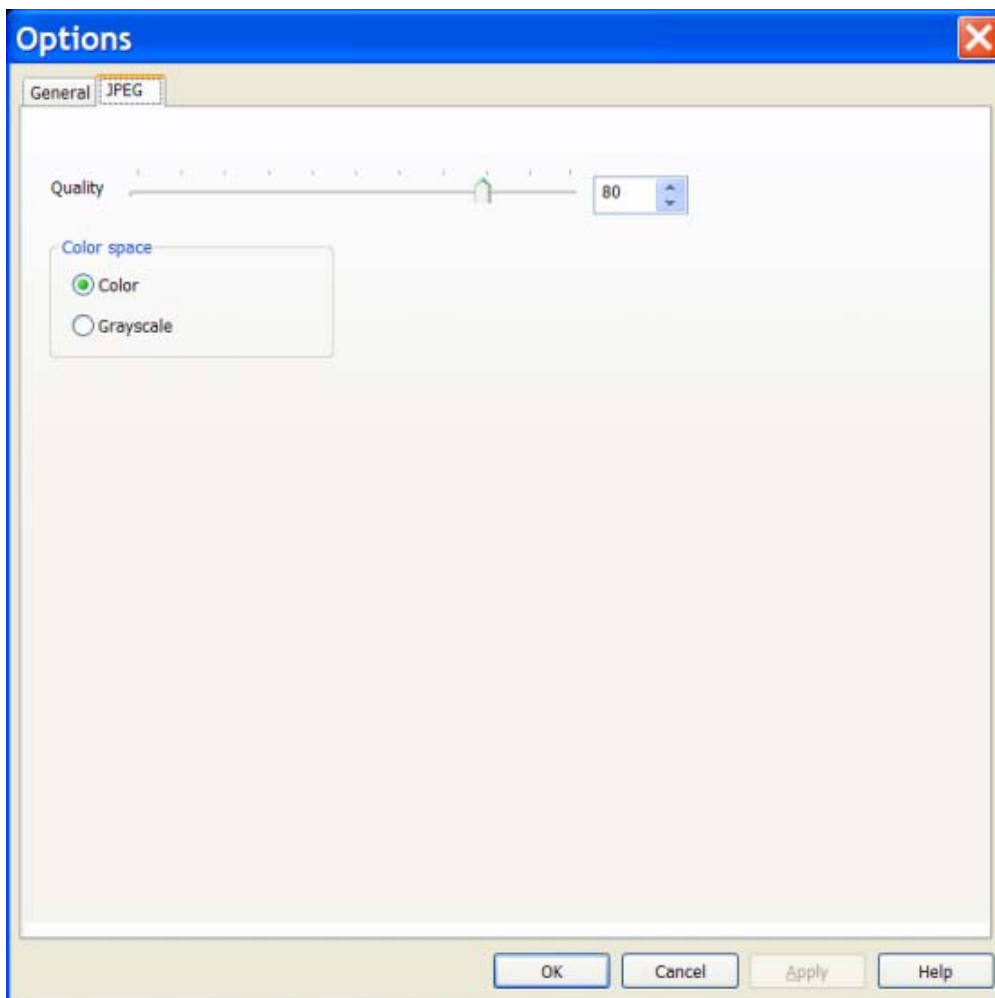

This dialog allows you to specify parameters of JPEG file / stream format.

The following options allow you to specify JPEG file / stream:

### "Quality" slider, edit, spin boxes

These control boxes allow you specifying a quality of the compressed JPEG image.

### "Color space" group box

This group box allow you to specify color space of JPEG image.

JPEG format allows to save color image in its original color form or convert color image into a gray (black and white) image. Size of a gray JPEG file is smaller than the size of a color JPEG file. Using gray image may be useful when color information is not required and size of the JPEG file has to be as small as possible for the given level of quality.

**Remarks**

JPEG is a lossy compression algorithm. When image is converted into the JPEG format some color information is lost. As a result a quality of the image compressed with JPEG algorithm becomes lower than it was originally in the uncompressed image. The loss of a quality depends on the level of compression. The higher level of compression in JPEG file, the lower level of quality.

Practically it means that there has to be found a compromise between quality and the level of compression acceptable for the concrete situation.

Level of quality in the uncompressed image is defined as 100%. Level of quality about 80% is considered usually as a high. Level a quality about 50% - 60% is considered as an average. And level of quality about 20% - 40% is considered as a low. These estimations are approximate, and may be different under specific conditions.

## "File formats: PNG" options dialog box

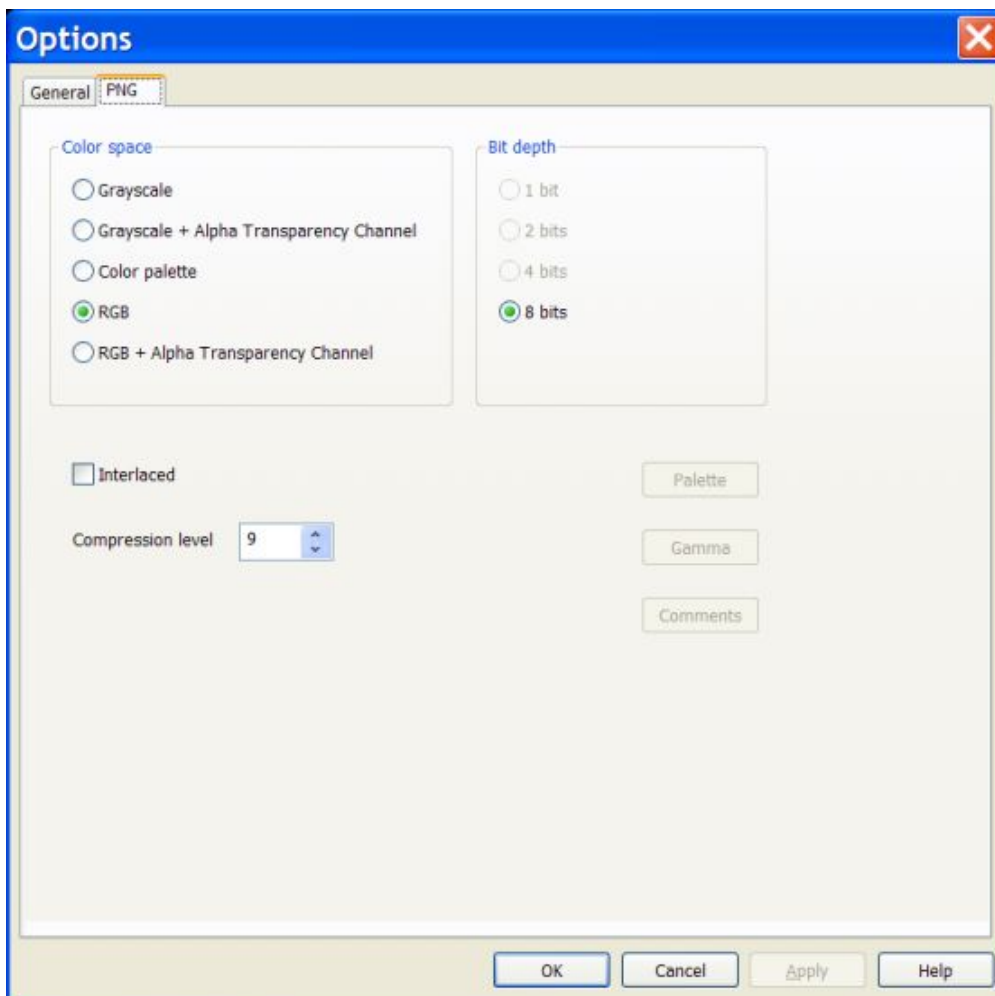

This dialog allows you to specify parameters of PNG file / stream format.

The following options allow you to specify PNG file / stream:

### "Color space" group box

This group box allows you to specify a color space used as an internal format in the PNG image.

Click a radio button in this group box to select a required color space.

**"Bit depth" group box**

This group box allows you to specify a bit depth of each color component.

Table below shows how many colors there are in the images with the different bit depth:

| Bit depth | Colors in the grayscale image | Colors in the color palette image | Colors in the color RGB image |
|-----------|-------------------------------|-----------------------------------|-------------------------------|
| 1         | 2                             | 2                                 | not applied                   |
| 2         | 4                             | 4                                 | not applied                   |
| 4         | 16                            | 16                                | not applied                   |
| 8         | 256                           | 256                               | 16777216                      |
| 16        | 65536                         | not applied                       | 281474976710656               |

Click a radio button in this group box to select a required bit depth.

**"Interlaced" check box**

This check box allows you to specify whether internally PNG image will be save as progressive or interlaced.

**"Compression" level edit and spin boxes**

These control boxes allow you to specify compression level of the PNG image.

The higher a level of compression, the smaller a size of the compressed file. But compression to the higher degree requires longer time.

Minimum level of compression is 0, maximum is 9.

At the modern PC compression of a single standard resolution image (640 x 480) is fast at all levels of compression. Therefore maximum compression level 9 is adequate in the majority of occasional situations.

Compression time becomes noticeable when size of image is much bigger than standard resolution, or when multiple images have to be compressed in real time. For example, when PNG format is used for saving a video stream to the hard disk. In that case a lower level of compression may be useful.

**Remarks**

PNG is a lossless compression algorithm. It means that color information is not lost in the PNG image, and a quality of an image converted into the PNG format is same as it was the original uncompressed image.

There are two major exceptions from this rule. PNG image internally may be presented in the different color spaces and with the different color bit depth. As a result some color information may be lost if during PNG compression:

- Color space of the original image is converted into another color space with a smaller number of color components.
- Bit depth of the original image is reduced.

For example, color information is lost when original color image is saved as a gray PNG image; or when original image with 8 bit color depth is saved as a 4 bit PNG image.

## "Reference frames" options dialog box

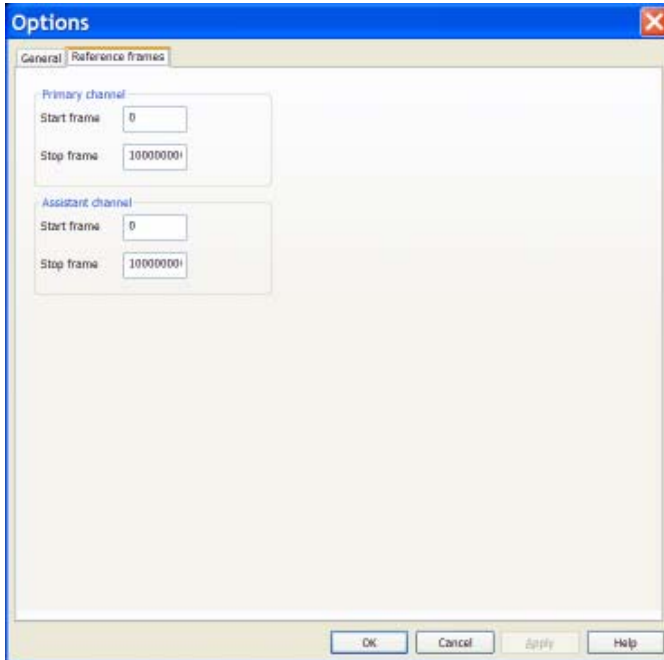

This dialog allows you to set start and stop reference frames used for playing a fragment of video sequence.

The following options allow you to set reference frames for the primary and assistant channels:

### "Start frame" and "Stop frame" edit boxes

Specify in these fields order numbers of the start reference frame and stop reference frame.

### Remarks

If channel is open, and playing for channels is enabled, and command "Start" is applied then video sequence begin to play. All frames placed within video sequence before start reference frame are skipped as fast as possible. Skipped frames are not displayed in the browser window.

Beginning from the start reference frame video sequence is played with normal speed and all frames are displayed in the browser window, until the stop reference frame is reached.

Playing is stopped when stop reference frame is reached.

To play very long video sequence without stops, set stop frame to some big number. Default value set by Breeze is 1,000,000,000. That value allows to play video at the frame rate 30 frames per second during 1 year and 3 months without stops.

Start and stop frames can also be set in the "Read stream" options dialog available via the main menu item "Options..." .



## 6. "File manager" dialog boxes

"Options" dialog boxes provides you select files and folders, as well as to open and save documents, files and streams.

Currently Breeze supports the following "File manager" dialogs:

|                |   |
|----------------|---|
| Open / Open To | This dialog displays general information about Breeze, including its edition and version.     |
| SaveAs         | This dialog display information about channels.   |
| Select folder  | This dialog allows you to enable / disable reading of input streams and set their parameters. |
| Close From     | This dialog allows you to enable / disable reading of input streams and set their parameters  |

## File "Open" / "Open To" dialog box

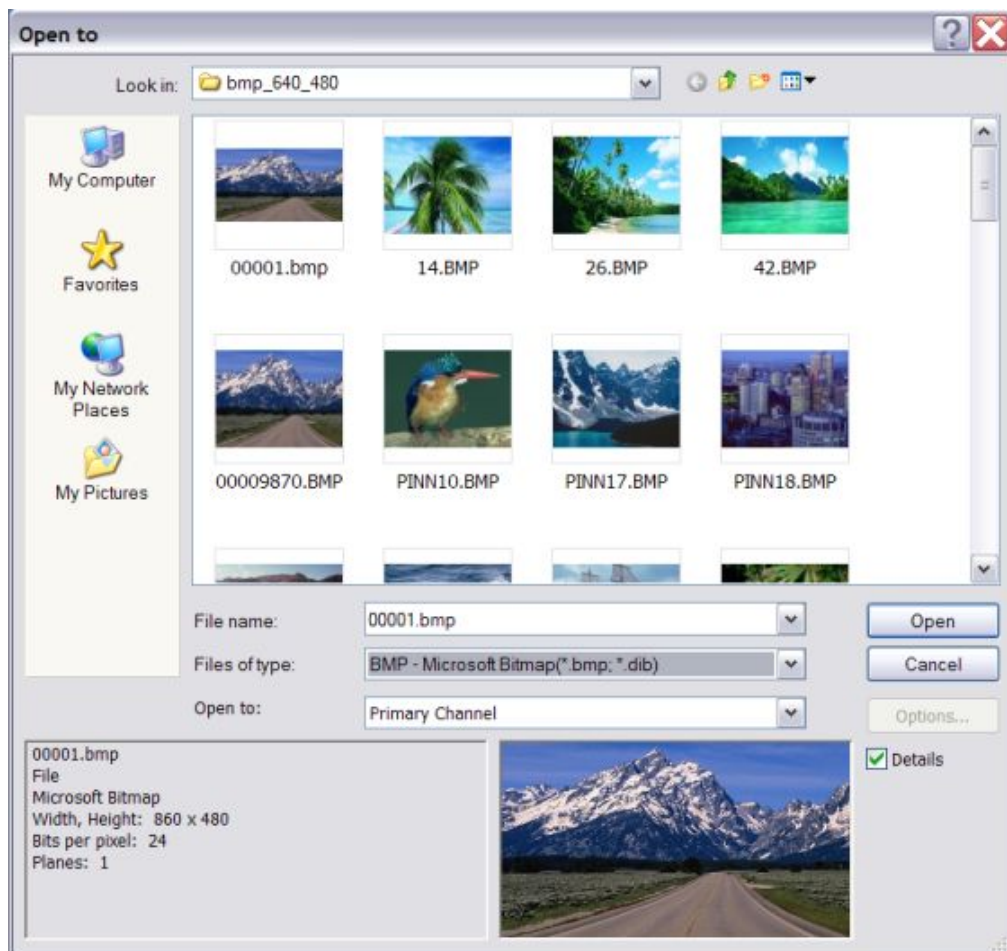

The following options allow you to specify which file to open:

### "File Name" combo box

Specifies the file you want to open. This box lists files with the extension you select in the Files of Type field.

### "Files of type" combo box

Specifies the type of file / stream you want to open.

### "Open To" combo box

Specifies the channel where file / stream will be open to.

### "Details" check box

This checkbox specifies whether to use info and preview panels of File dialog box (turn On / Off) when cursor in the file list window is set to the new position.

When info and preview functions are turned off, scrolling through the file list is faster. Usually info and preview operations are so fast that it is difficult to notice difference between speed of scrolling in checked and unchecked states. An impact of image preview operation is noticeable only when sizes of images displayed in the preview window are very big, or if files / streams are accessed at the remote computer via network with a low data access speed.

### **"Options..." button**

Click this button, if it is enabled, to open a dialog where you can specify details of data format, data access etc. for the currently selected file / stream.

There are exists popular file / stream data formats which can not be identified precisely by the specific signature information kept in the file name, file name extension, in the the file header contents etc. Often signature or file name extension information allows identifying a general type only of a file data format. As a result those files / streams can not be recognized and visualized properly. For example, there exists hundreds YUV video and image formats with the same "yuv" file extension.

Breeze recognizes a number of that sort situations and offer the user an option to specify data format. When such file / stream is selected, Breeze enables the "Options..." button, and you can access dialog where details of data format for the selected file / stream can be specified. Picture in the preview panel is changed according to the specifications set in the dialog.

### **"Look in" combo box**

Specifies network address, computer, drive, directory etc. where you may look for file / streams.

### **Drives**

Specifies the drive in which Breeze stores the file that you want to open.

### **Directories**

Specifies the directory in which Breeze stores the file that you want to open.

### **Network**

Click this button to connect to a network location, assigning it a new drive letter.

## File Save / Save As dialog box

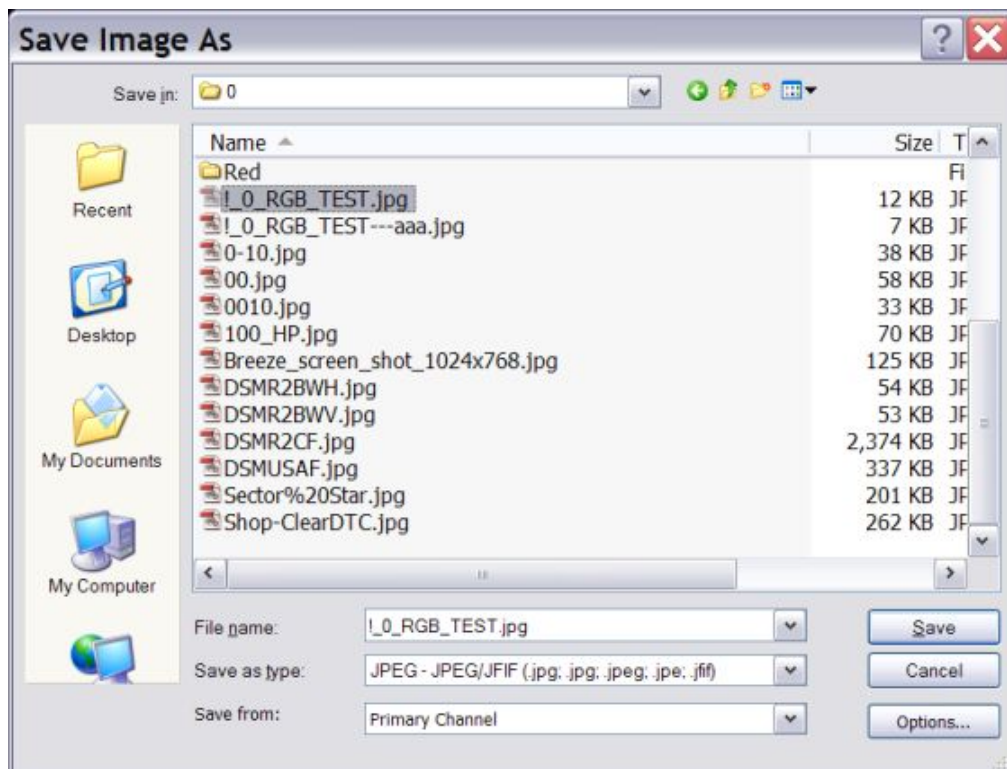

The following options allow you to specify the name and location of the file you're about to save:

### "File Name" combo box

Specifies a file name to save a document with a different name. Breeze adds the extension you specify in the Save As type box.

### "Save as type" combo box

Specifies the type of file / stream format which will be used to save a document.

### "Save from" combo box

Specifies the channel where file / stream will be saved from.

### "Options..." button

Click this button, if it is enabled, to open a dialog where you can specify details of data format, data access etc. for the currently selected file / stream.

Currently Breeze allows to specify JPEG, JPEG2000, PNG, GIF, TIFF formats.

**"Look in" combo box**

Specifies network address, computer, drive, directory etc. where file / stream will be saved at.

**Drives**

Specifies the drive in which you want to store the document.

**Directories**

Specifies the directory in which you want to store the document.

**Network**

Click this button to connect to a network location, assigning it a new drive letter.

## Select folder dialog box

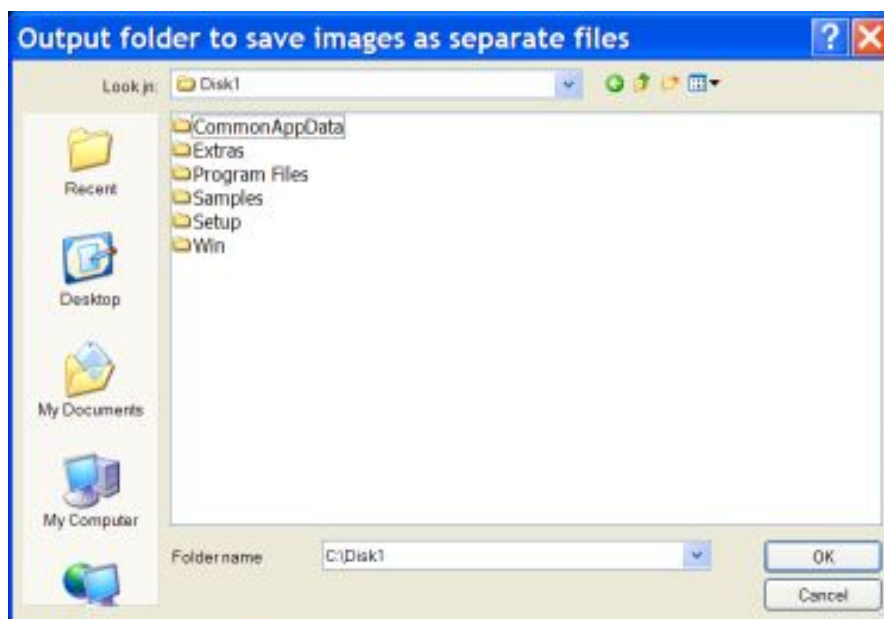

This dialog allows you to select a folder.

Folder can be selected from the folder list, from the history list attached to the combo box Folder name, entered manually in the edit box Folder name, or pasted to that edit box from the clipboard.

The following options allow you to specify which folder to open:

### "Look in" combo box

Specifies network address, computer, drive, directory etc. where you may look for a folder.

### Drives

Specifies the drive where you may look for a folder.

### Directories

Specifies the directory where you may look for a folder..

### Network

Click this button to connect to a network location, assigning it a new drive letter.

## "Close From" dialog box

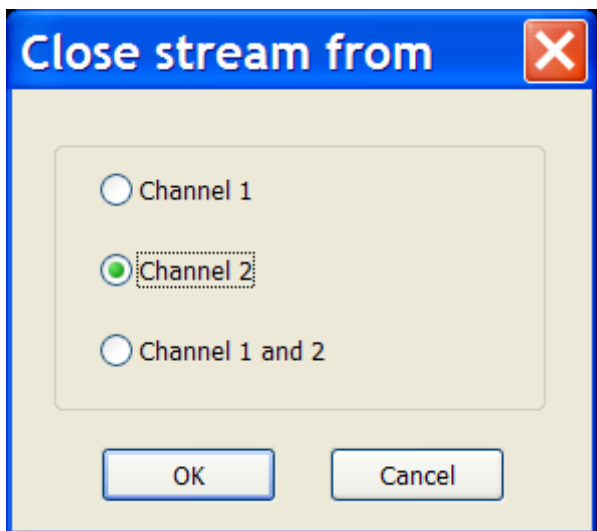

This dialog allows you to close data stream from the channel of the open browser window.

This dialog is accessed via the File menu command Close From.

**Close From** does not close browser window itself.

If only one channel, primary or assistant, is open then Breeze closes that open channel.

If both channels, primary and assistant, are open, then Breeze displays "Close From" dialog where you can select which channel has to be closed. Make a selection and click button "OK" if you want to close selected channels, or click button "Cancel" if you want to cancel **Close From** operation.

## Controller panel of a browser window

Controller panel allows you to monitor and configure several important features of the Breeze.

### "Mode" text boxes

These text boxes show current operational modes for the primary and assistant channel browser window.

### "Play" text boxes

These text boxes indicates whether playing is enabled or not in the primary and assistant channel.

For details see commands: "Play primary channel" and "Play assistant channel".

### "Reverse" text boxes

These text boxes indicates whether reverse playing direction is enabled or not in the primary and assistant channel.

For details see commands: "Reverse primary channel" and "Reverse assistant channel".

### "Save" text boxes

These text boxes indicates whether "Save" operation is enabled or not in the primary and assistant channel.

For details see commands: "Save primary channel" and "Save assistant channel".

### "Video ports" buttons

These buttons allow you to select video ports which will be connected to the primary and assistant video panels.

Upper row of buttons connect selected video port to the primary video panel and lower row of button connects selected video port to the assistant video panel.

Any of 4 video ports can be connected to any video panel .

### "Frame" text boxes

These text boxes display order numbers of the currently processed frames in the primary and assistant channels.

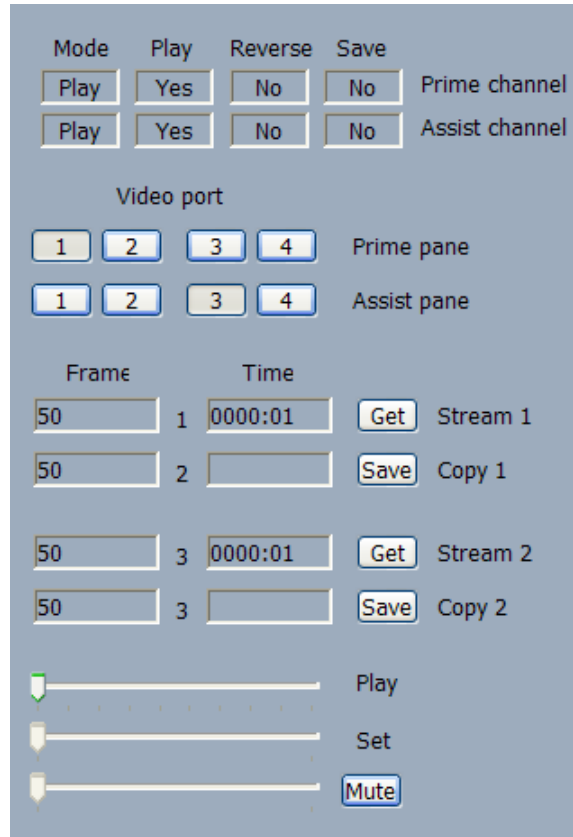

of a



"Frame" text boxes are used when browser window is in the "Play" mode.

There are 4 "Frame" text boxes aligned in the column. They corresponds to the video ports 1, 2, 3, 4.

"Frame" text boxes 1 and 3 show order numbers of frames in the video output ports 1 and 3, used for the major video output operations. "Frame" text boxes 2 and 4 show order numbers of frames in the video output ports 2 and 4, used for the auxiliary video output operations.

For example, auxiliary video output ports 2 and 4, and corresponding to them auxiliary "Frame" text boxes 2 and 4, are used for "Capture image" operations. "Frame" text boxes 2 and 4 show order number of the captured frames.

Displaying a frame index and time info in the controller panel can be disabled. To do that uncheck a check box "Enable frame index and time info" in the "Video" options dialog.

### **"Time" text boxes**

These text boxes display relative time of the currently processed frames in the primary and assistant channels.

"Time" text boxes are used when browser window is in the "Play" mode.

There are 4 "Time" text boxes aligned in the column. They corresponds to the video ports 1, 2, 3, 4.

"Time" text boxes 1 and 3 show relative time for the frames processed in the video output ports 1 and 3, used for the major video output operations. "Time" text boxes 2 and 4 show relative time for the frames processed in the video output ports 2 and 4, used for the auxiliary video output operations.

Relative time is calculated relative to the very start of playing a video with the frame rate selected in the "Video" options dialog. It is assumed that the order number of the very first frame is 0. For example for the frame rate 25 frames per second, frame number 24 corresponds to the moment of the time 1 second since the very start of playing a video sequence.

Displaying a frame index and time info in the controller panel can be disabled. To do that uncheck a check box "Enable frame index and time info" in the "Video" options dialog.

### **"Get" and "Save" buttons**

These buttons allows you to capture images from the channels in the "Play" mode.

For more detailed information about "Capture image" operations see the section "Remarks" in the help topic "Capture image" options dialog.

Upper buttons "Get" and "Save" are used for capturing an image from the primary channel. Lower buttons "Get" and "Save" are used for capturing an image from the assistant channel.

### **"Play" slider**

You may use this slider to regulate frame rate of playing a video.

Real frame rate of playing a video, set in the "Video" options dialog, can be reduced from the maximum value to zero by setting the "Play" slider.

**"Set" slider**

This slider allows you to set a position for the currently processed frame in the frame cash buffers.

**"Audio" slider**

This slider allows you to set a level of audio output.

**Remarks**

Currently controls in the controller panel of a browser window are organized in 4 groups:

- Text boxes indicating operational modes and state of the primary and assistant channels: "Mode", "Play", "Reverse", "Save".
- Buttons allowing to select a video output port which will be connected to the primary and assistant video panels.
- Text boxes displaying order numbers of the currently processed frames and relative time for those frames; each line include buttons allowing to capture processed images from the video panels
- Sliders allowing to set:
  - Frame rate for playing a video,
  - Position in the frame cash buffers,
  - Level of audio out.

## 7. Install/Uninstall/Repair/Activate

### ***Install the Breeze***

Breeze installation package is available for downloading at the [www.DiscoveryBiz.Net](http://www.DiscoveryBiz.Net).

It is a single executable file, presenting self extractable compressed archive, encoded with password.

Name of the Breeze, Light Edition downloadable file is "Breeze\_5.3.2.L.exe" or similar. Name of the Breeze, Standard Edition downloadable file is "Breeze\_5.3.2.S\_DF.exe" or similar.

Further in the text a downloadable executable archive file will be called Breeze\_5x.exe.

Breeze package can be installed only if a proper password, called "Serial number" is available.

Serial number required to install Breeze software will be sent at you e-mail address by the customer support service.

There are also available versions of Breeze with the preset serial number. Those versions do not require user to enter a serial number during installation.

During installation setup program displays several dialogs where user can modify default configuration parameters of the installed Breeze software package.

**If another version of "Breeze" is already installed at the computer where you plan to install a newer version, then that currently installed version of Breeze has to be removed before a newer version will be installed.**

See section "6. Uninstall the Breeze" of this guide for instructions how to uninstall Breeze.

### **Installation "Step by step"**

1. Locate setup file "Breeze\_5.exe" and start it.
2. Program starts and displays the very first dialog titled "Welcome to the Breeze Software Wizard".

Read instructions displayed in the dialog and then click button "Next" if you want to continue installation or click button "Cancel" if you want to cancel installation.

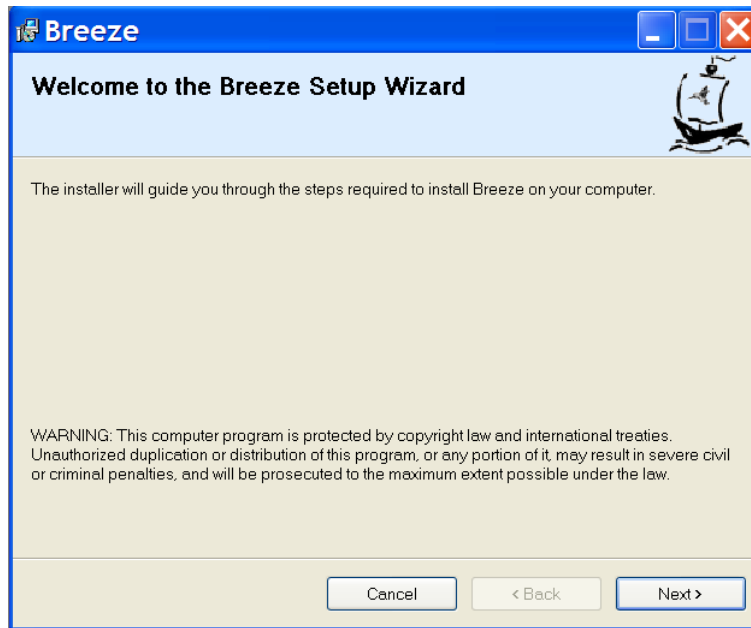

3. Dialog "License Agreement" is displayed.

Read "License Agreement" and select one of the buttons "I do not agree" or "I agree".

Click button "Next" if you want to continue installation or click button "Cancel" if you want to cancel installation.

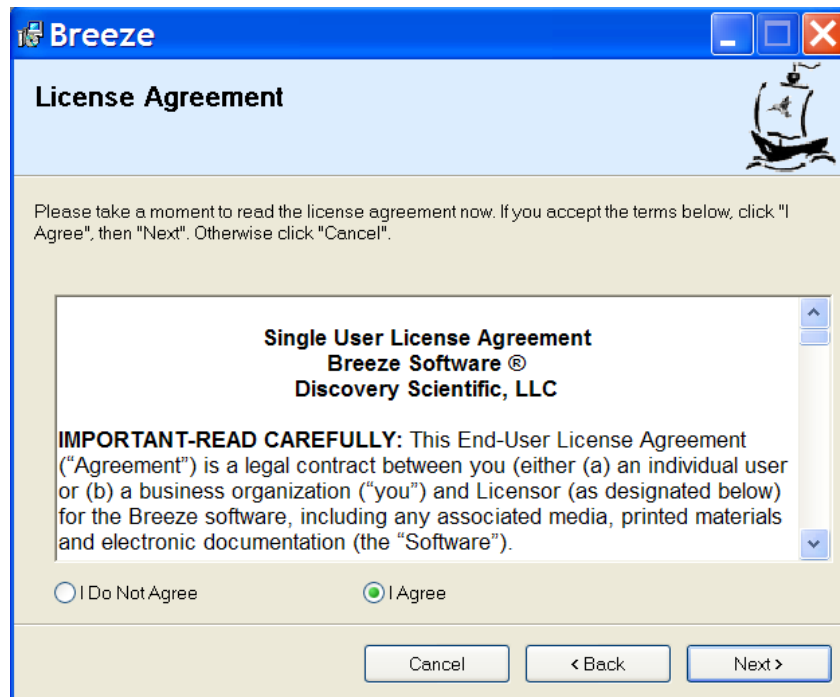

4. Dialog "Customer information" is displayed.

Enter customer data and serial number if it is required. If you are installing a version of the Breeze software with a preset serial number then that serial number will be displayed in the "Serial number" edit boxes.

Click button "Next" if you want to continue installation or click button "Cancel" if you want to cancel installation.

If entered (or preset) serial number is correct then installation program will continue installation. If serial number is incorrect the installation program will display a warning, and return you to the "Customer information" dialog.

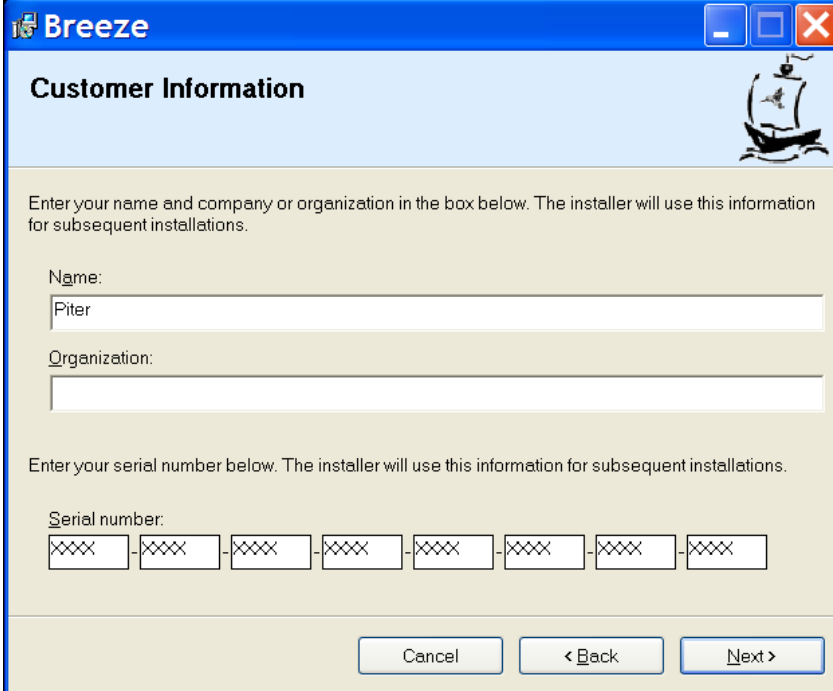

The screenshot shows a Windows-style dialog box titled "Breeze" with a blue header bar. The main title is "Customer Information" in bold black text. To the right of the title is a small icon of a sailing ship. Below the title bar, there is a light blue header area. The main content area has a light beige background and contains the following text and controls:

Enter your name and company or organization in the box below. The installer will use this information for subsequent installations.

Name:

Organization:

Enter your serial number below. The installer will use this information for subsequent installations.

Serial number:  
 -  -  -  -  -  -

At the bottom of the dialog are three buttons: "Cancel", "< Back", and "Next >".

5. "Select installation folder" dialog is displayed.

Select a folder where you want to install Breeze software or use default value.

Select variant of installation, "Everyone" or "Just me".

Click button "Next" if you want to continue installation or click button "Cancel" if you want to cancel installation.

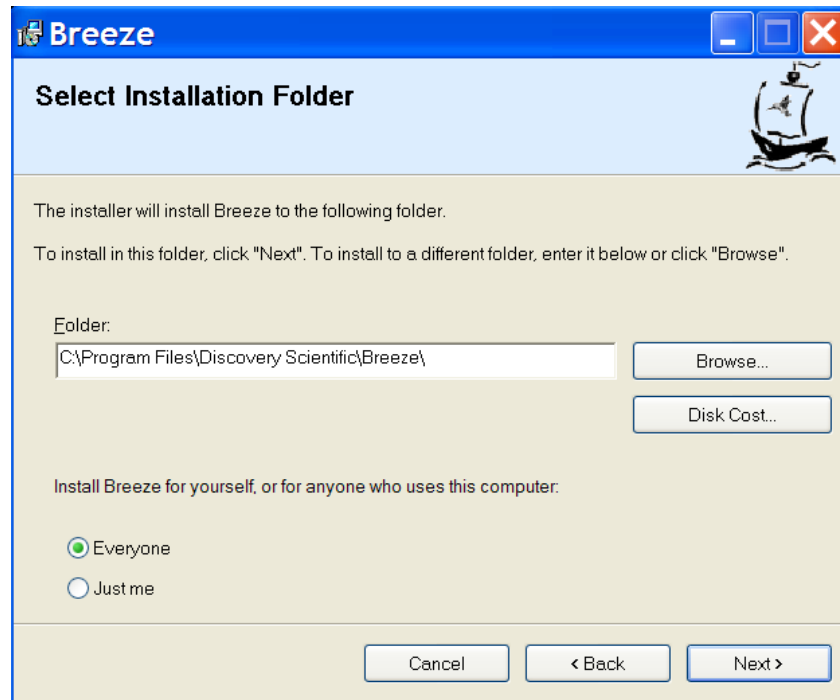

6. "Confirm installation" dialog is displayed.

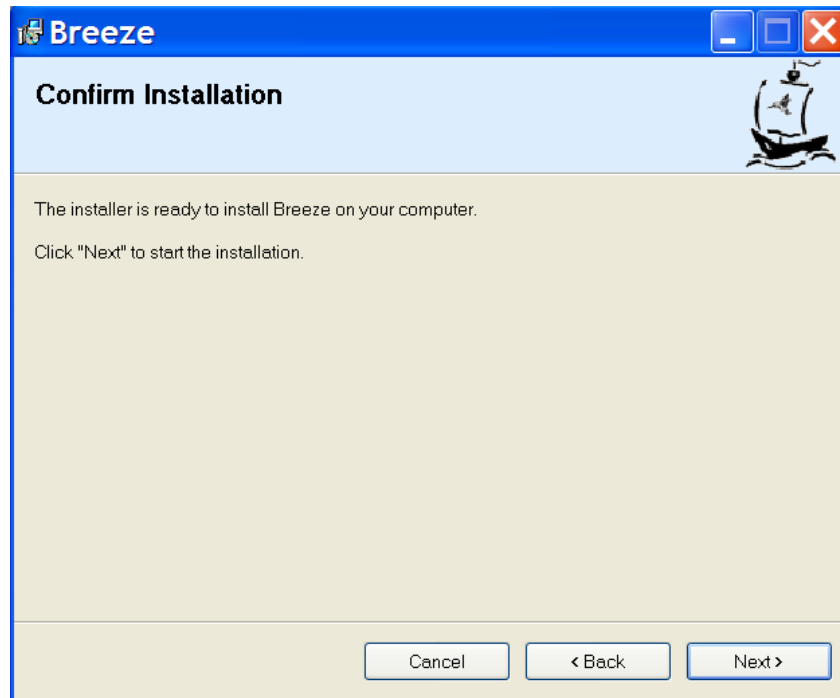

Click button "Next" if you want to continue installation or click button "Cancel" if you want to cancel installation.

7. Installation starts and dialog showing a progress of installation is displayed. When installation is complete the dialog "Installation Complete" is displayed.

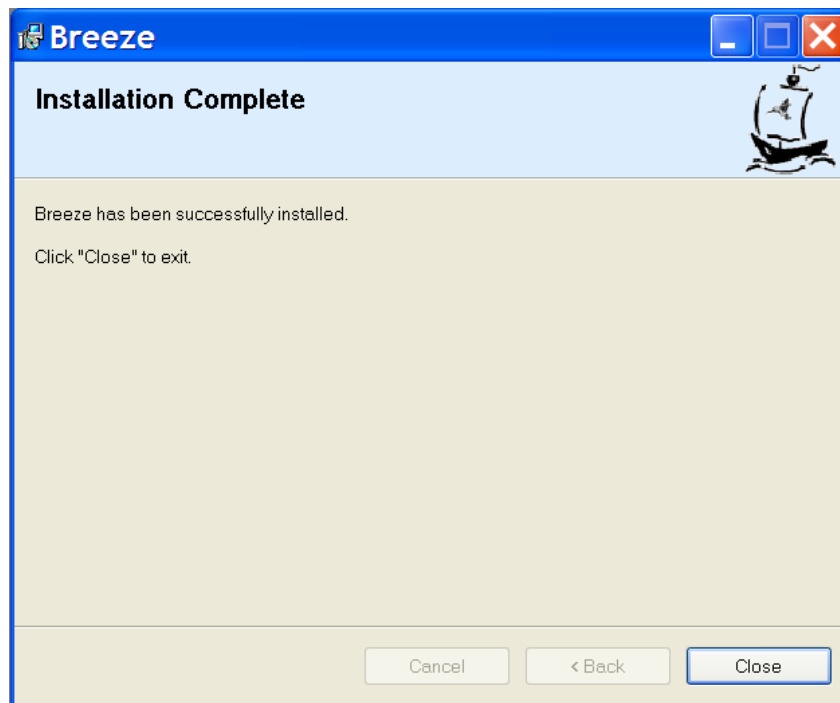

Click button "Close" to complete installation.

Now you may open "Start" menu and find menu item "Breeze".

To start working with Breeze, open "Breeze" menu and then click sub item "Breeze".

Another way to start Breeze is to open computer "Desktop", find Breeze icon and click it.



## **Uninstall the Breeze**

Breeze package can be uninstalled via the standard Windows dialog "Add or Remove Programs" or via the item in the Breeze menu "Uninstall or Repair Breeze".

### **Uninstall Breeze via the Windows control "Add Remove Programs"**

To open dialog "Add or Remove Programs" click "Start" menu, and then item "Control Panel" in the opened "Start" menu.

In the Control Panel select and click item "Add or Remove Programs". Dialog "Add or Remove Programs" will open.

Select in the list of installed programs item "Breeze". To verify that selected item is correct, click link "Click here for support information". In opened window "Support info" item "Publisher" should be "Discovery Scientific, LLC".

To start uninstall process click button "Remove".

Click button "Yes" in the dialog asking "Are you sure you want to remove Breeze from you computer?" if you are sure to do that. Click button "No" if you are not sure.

If button "Yes" has been clicked then Windows open dialog with horizontal progress bar indicating a state of uninstall process. Dialog will be closed after uninstall process is completed.

## Uninstall Breeze via the item "Uninstall or Repair Breeze" in the Start menu

To start uninstall process click "Start" menu and then item "All Programs".

In open "All Programs" menu list select menu item "Breeze, and then sub item "Uninstall or Repair Breeze". Windows will open dialog "Welcome to the Breeze Setup Wizard".



Click radio button "Remove Breeze".

If you are not sure that you want to uninstall Breeze then click button "Cancel" and uninstall process will be stopped.

If you are sure that you want to uninstall Breeze then click button "Finish".

If button "Finish" has been clicked then Windows open dialog with horizontal progress bar indicating a state of uninstall process. Dialog will be closed after uninstall process is completed.

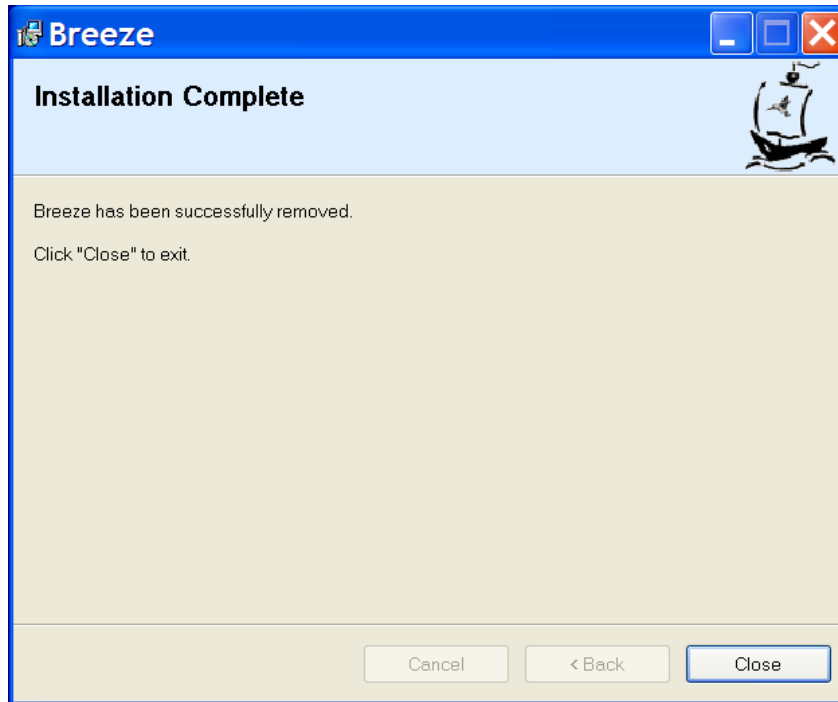

## **Repair the Breeze**

If some components of Breeze package were accidentally removed or damaged, then integrity of the package and all its components can be repaired. Breeze package can be repaired via the standard Windows dialog "Add or Remove Programs" or via the item in the Breeze menu "Uninstall or Repair Breeze".

### **Repair Breeze via Windows control "Add Remove Programs"**

To open dialog "Add or Remove Programs" click "Start" menu, and then item "Control Panel" in the opened "Start" menu.

In the Control Panel select and click item "Add or Remove Programs". Dialog "Add or Remove Programs" will open.

Select in the list of installed programs item "Breeze". To verify that selected item is correct, click link "Click here for support information". In opened window "Support info" item "Publisher" should be "Discovery Scientific, LLC".

To start repair process click button "Change". Windows open dialog "Welcome to the Breeze Setup Wizard".

Click radio button "Repair Breeze".

If you are not sure that you want to repair Breeze then click button "Cancel" and repair process will be stopped.

If you are sure that you want to repair Breeze then click button "Finish".

If button "Finish" has been clicked then Windows open dialog with horizontal progress bar indicating a state of repair process. Dialog will be closed after repair process is completed.

## Repair Breeze via item "Uninstall Breeze" in the Start menu

To start repair process click "Start" menu and then item "All Programs".

In open "All Programs" menu list select menu item "Breeze, and then sub item "Uninstall or Repair Breeze". Windows open dialog "Welcome to the Breeze Setup Wizard".

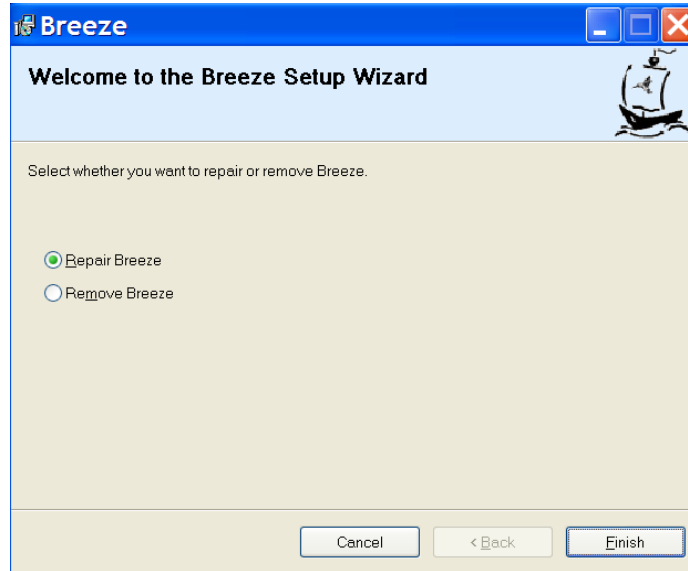

Click radio button "Repair Breeze".

If you are not sure that you want to repair Breeze then click button "Cancel" and repair process will be stopped.

If you are sure that you want to repair Breeze then click button "Finish".

If button "Finish" has been clicked then Windows open dialog with horizontal progress bar indicating a state of repair process. Dialog will be closed after repair process is completed.

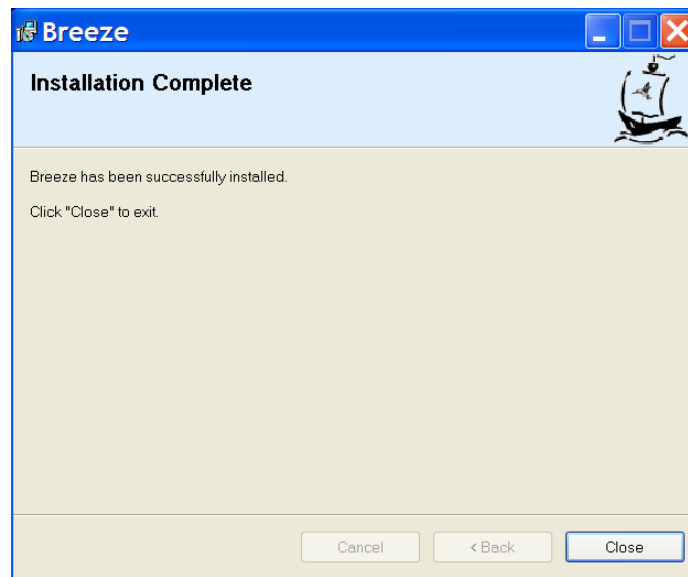

## Activate the Breeze

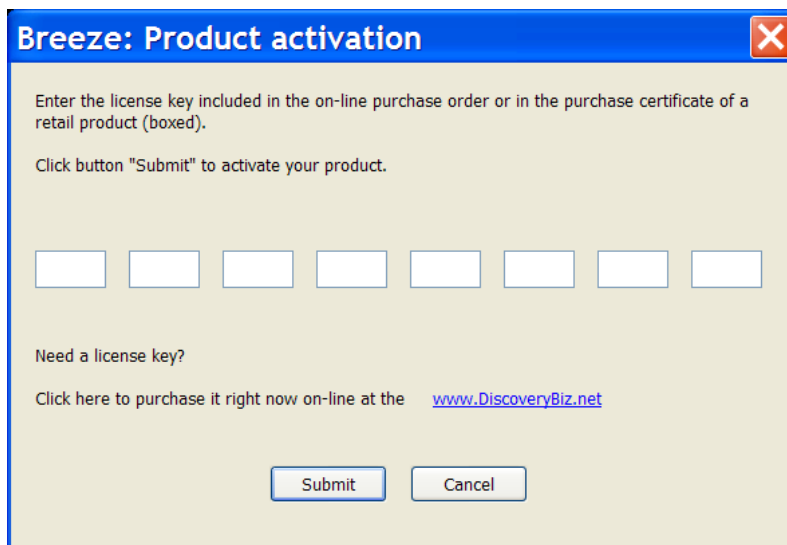

This dialog allows you to activate Breeze.

Commercial Breeze software packages include 30 days trial evaluation period.

Evaluation period starts immediately after installing software. During this period functionality of software is same as in the activated software. To continue using software after evaluation period expires, software has to be activated with a License key.

License key for downloaded software can be purchased on-line at the [www.DiscoveryBiz.Net](http://www.DiscoveryBiz.Net) (see item "Purchase" in the menu).

Activation license key is issued immediately after purchasing a product.

Subscription access key for packages with 12 months subscription for free download upgrades, is issued immediately after purchasing a product.

Retail packages include product certificate where license key can be found.

After license key is obtained, Breeze can be activated. During evaluation period "About" dialog box shows button "Activate". Click this button to open the activation dialog. Enter license key in the activation dialog and then press button "Submit". Please, enter to the edit boxes only digits and letters of license key; do not enter dashes.

Before activation "About" dialog displays text information showing how many days are left for the trial evaluation. "About" dialog displays activation license key after successful activation. Button "Activate" is not shown in the "About" dialog box after activation.

## 8. Breeze license

### Single User License Agreement

#### Breeze Software

Copyright © 1989 – 2007 Discovery Scientific, LLC

**IMPORTANT-READ CAREFULLY:** This End-User License Agreement ("Agreement") is a legal contract between you (either (a) an individual user or (b) a business organization ("you") and Licensor (as designated below) for the Breeze software, including any associated media, printed materials and electronic documentation (the "Software").

THE USE OF THIS SOFTWARE IS SUBJECT TO THE SOFTWARE LICENSE TERMS OF DISCOVERY SCIENTIFIC, LLC AND OTHER LICENSORS, WHOSE SOFTWARE MAY BE BUNDLED WITH THIS PRODUCT. BY YOUR USE OF THE SOFTWARE INCLUDED WITH THIS PRODUCT YOU AGREE TO THE LICENSE TERMS REQUIRED BY THE LICENSOR OF THAT SOFTWARE, AS SET FORTH BELOW.

By clicking on the "Yes" ("I ACCEPT", "I AGREE", etc.) button, by opening the package that contains the Software, or by copying, downloading, accessing or otherwise using the Software, you agree to be bound by the terms of this Agreement and you represent that you are authorized to enter into this Agreement on behalf of your corporate entity (if applicable). If you do not wish to be bound by the terms of this Agreement, click the "No" ("I DO NOT ACCEPT", "DO NOT AGREE, etc.) button, and do not install, access or use the Software.

IF YOU DO NOT AGREE TO THE LICENSE TERMS APPLICABLE TO THE SOFTWARE, YOU MAY RETURN THE ENTIRE UNUSED PRODUCT TO THE SOURCE FROM WHICH YOU OBTAINED IT.

As used herein, "Licensor" and "Discovery Scientific" mean Discovery Scientific, LLC, Delaware USA Company

#### RETURN AND REFUND POLICY

Discovery Scientific does not permit the return of or offer refunds for the following products:

1. Retail software in the open box with destroyed original seal
2. Electronic software downloads

An original purchaser of retail (boxed) software, who has not accepted the terms of this Agreement, may return the Software to the place of purchase within 30 days of the date of purchase, for a refund. Please contact Discovery Scientific for details of return / refund at [www.DiscoveryBiz.net](http://www.DiscoveryBiz.net) or via e-mail [Support@DiscoveryBiz.net](mailto:Support@DiscoveryBiz.net).

#### EVALUATION SOFTWARE

If you have received the Software for purposes of evaluation, regardless of how labeled, the use of the Software is limited to a specified period of time, as detailed in the email accompanying the download instructions (the "Evaluation Period") and all use will be governed by the terms set forth below.

1. Grant of License. Licensor grants you a limited, personal, internal use, non-exclusive, non-transferable license to use the Software solely to evaluate its suitability for your internal business requirements during the Evaluation Period. Without limiting the foregoing, you may not use the Software during the Evaluation Period to create publicly distributed computer software or for any other commercial purpose. This license may be terminated by Licensor at any time upon notice to you and will automatically terminate, without notice, upon the first to

occur of the following: (a) the completion of your evaluation of the Software or (b) the expiration of the Evaluation Period.

2. Limited Use Software. Portions of the full-use version of the Software may be withheld or unusable and use of the Software may require accessing portions of the Software remotely through the Internet. Full use of the Software may be restricted by technological protections.

3. Disclaimer of Warranty. THE SOFTWARE IS PROVIDED ONLY FOR EVALUATION PURPOSES ON AN "AS IS" BASIS. LICENSOR EXPRESSLY DISCLAIMS ALL WARRANTIES, INCLUDING THE IMPLIED WARRANTIES OF MERCHANTABILITY, FITNESS FOR A PARTICULAR PURPOSE, AND NON-INFRINGEMENT.

4. Limitation of Liability. IN NO EVENT WILL LICENSOR BE LIABLE FOR ANY DAMAGES, INCLUDING LOST PROFITS OR DATA, OR OTHER INCIDENTAL OR CONSEQUENTIAL DAMAGES, ARISING OUT OF THE USE OR INABILITY TO USE THE SOFTWARE OR ANY DATA SUPPLIED THEREWITH, EVEN IF LICENSOR HAS BEEN ADVISED OF THE POSSIBILITY OF SUCH DAMAGES, OR FOR ANY CLAIM BY ANY OTHER PARTY.

## SOFTWARE LICENSE

In return for acquiring a license to use the Software, which may include software from third party licensors and patches made available by Software, and the related documentation, you agree to the following terms and conditions:

### 1. License.

This Agreement grants you, the Licensee, a license to:

(a) use the Software on a single computer system, which is not intended for use by more than ten (10) users; and (b) make one copy of the Software in machine readable form solely for back-up purposes, provided you reproduce copyright proprietary legends of Licensor. Notwithstanding the foregoing, the Software may be used on the home, laptop or other secondary computer of the principal user of the Software, and an additional copy of the Software may be made to support such use. As used in this license, the Software is "in use" when it is either loaded into RAM or installed on a hard disk or other permanent memory device. The Software may be "in use" on only one computer at any given time. (Different license terms and fees are applicable for networked or multiple user applications.) As a specific condition of this license, you agree to use the Software in compliance with all applicable laws, including copyright laws, and that you will not copy, transmit, perform or distribute any audio or other content using the Software without obtaining all necessary licenses or permissions from the owner of the content.

### 2. Restrictions.

You may not distribute copies of the Software to others (including distribution on the Internet) or electronically transfer the Software from one computer to another over a network. You may not post or otherwise make available the Software, or any portion thereof, in any form, on the Internet. You may not use the Software in a computer service business, including in time sharing applications. The Software contains trade secrets and, in order to protect them, you may not decompile, reverse engineer, disassemble, or otherwise reduce the Software to a human-perceivable form. YOU MAY NOT MODIFY, ADAPT, TRANSLATE, RENT, LEASE, LOAN, RESELL FOR PROFIT, DISTRIBUTE, NETWORK OR CREATE DERIVATIVE WORKS BASED UPON THE SOFTWARE OR ANY PART THEREOF.

### 3. Ownership of Software.



As Licensee, you own the media upon which the software is recorded or fixed, but Licensor and its licensors retain title and ownership of the Software recorded on the original media and all subsequent copies of the Software, regardless of the form or media in which or on which the original and other copies may exist. This license is not a sale of the Software or any copy.

#### 4. Confidentiality.

You agree to maintain the Software in confidence and that you will not disclose the Software to any third party without the express written consent of Licensor. You further agree to take all reasonable precautions to preclude access of unauthorized persons to the Software.

#### 5. Term.

This license is effective until January 1, 2050, unless terminated earlier. You may terminate the license at any time by destroying the Software (including the related documentation) together with all copies or modifications in any form. Licensor will have the right to terminate our license immediately if you fail to comply with any term or condition of this Agreement. Upon any termination, including termination by you, you must destroy the Software (including the related documentation), together with all copies or modifications in any form.

#### 6. Special Terms Applicable to Additional Tools and Databases.

Where an additional tool or database is included with the Software, you acknowledge that it is licensed only in connection with the use of the Software to perform operations implemented by the "main" executable of Software, and that the additional tool or database and all data derived there from must be maintained in confidence in accordance with the provisions of Section 4. This license does not grant you any rights to distribute or disclose such tool or database or data.

#### 7. Limited Warranty.

Licensor and its licensors warrant only that the Software will perform substantially in accordance with the accompanying written documentation for a period of thirty (30) days from the date of your Software purchase receipt. LICENSOR AND ITS LICENSORS DO NOT AND CANNOT WARRANT THE RESULTS YOU MAY OBTAIN BY USING THE SOFTWARE OR DOCUMENTATION. THE FOREGOING STATES THE SOLE AND EXCLUSIVE REMEDIES LICENSOR OR ITS LICENSORS WILL PROVIDE FOR BREACH OF WARRANTY. EXCEPT FOR THE FOREGOING LIMITED WARRANTY, LICENSOR MAKES NO WARRANTIES, EXPRESSED OR IMPLIED, INCLUDING, BUT NOT LIMITED, AS TO NON-INFRINGEMENT OF THIRD PARTY RIGHTS, MERCHANTABILITY OR FITNESS FOR A PARTICULAR PURPOSE. Some states do not allow the exclusion of implied warranties or limitations on how long an implied warranty may last, so the above limitations may not apply to you. This warranty gives you specific legal rights and you may also have other rights which vary from state to state.

The entire liability of Licensor and its licensors, and your exclusive remedy for a breach of this warranty, shall be: (a) the replacement of the Software not meeting the above limited warranty which is returned to Licensor; or (b) if Licensor or its distributor is unable to deliver replacement Software, you may terminate this Agreement by returning the Software and your money will be refunded.

#### 8. Limitation of Liability.

IN NO EVENT WILL LICENSOR OR ITS LICENSORS BE LIABLE TO YOU FOR ANY INCIDENTAL, CONSEQUENTIAL OR INDIRECT DAMAGES, INCLUDING ANY LOST PROFITS, LOST SAVINGS, OR LOSS OF DATA, EVEN IF LICENSOR HAS BEEN ADVISED OF THE POSSIBILITY OF SUCH DAMAGES, OR FOR ANY CLAIM BY ANY OTHER PARTY. Some states do not allow the exclusion or limitation of special, incidental, or consequential damages, so the above limitation or exclusion may not apply to you.

## 9. General.

You acknowledge that you have read this Agreement, understand it, and that by using the Software you agree to be bound by its terms and conditions. You further agree that it is the complete and exclusive statement of the agreement between Licensor and you, and supersedes any proposal or prior agreement, oral or written, and any other communication between Licensor and you relating to the subject matter of this Agreement. No additional or any different terms will be enforceable against Licensor unless Licensor gives its express consent, including an express waiver of the terms of this Agreement, in writing signed by an officer of Licensor. You assume full responsibility for the use of the Software and agree to use the Software legally and responsibly. This Agreement shall be governed by the law of state Delaware, except as to copyright matters, which are covered by Federal law. This Agreement is deemed entered into at Wilmington, Delaware, USA by both parties. Should any provision of this Agreement be declared unenforceable in any jurisdiction, then such provision shall be deemed severable from this Agreement and shall not affect the remainder hereof. All rights in the Software not specifically granted in this Agreement are reserved by Licensor.